



Distributed by

i-Tech Company LLC

TOLL FREE: (888) 483-2418 • EMAIL: info@i-techcompany.com •

WEB: www.i-techcompany.com

NBB-1600-D20/D16 Series

Network Boot Bars

Models:

NBB-1600-D20

NBB-1600E-D20

NBB-1600CE-D16

User's Guide



Warnings and Cautions:

INSTALLATION INSTRUCTIONS



SECURE RACKING

If Secure Racked units are installed in a closed or multi-unit rack assembly, they may require further evaluation by Certification Agencies. The following items must be considered.

1. The ambient within the rack may be greater than room ambient. Installation should be such that the amount of air flow required for safe operation is not compromised. The maximum temperature for the equipment in this environment is 45°C. Consideration should be given to the maximum rated ambient.
2. Installation should be such that a hazardous stability condition is not achieved due to uneven loading.

INPUT SUPPLY

Check nameplate ratings to assure there is no overloading of supply circuits that could have an effect on overcurrent protection and supply wiring.

GROUNDING

Reliable earthing of this equipment must be maintained. Particular attention should be given to supply connections when connecting to power strips, rather than direct connections to the branch circuit.

No Serviceable Parts Inside; Authorized Service Personnel Only

Do not attempt to repair or service this device yourself. Internal components must be serviced by authorized personnel only.

- **Shock Hazard - Do Not Enter**

Disconnect Power

If any of the following events are noted, immediately disconnect the unit from the outlet and contact qualified service personnel:

1. If the power cord becomes frayed or damaged.
2. If liquid has been spilled into the device or if the device has been exposed to rain or water.

Two Power Supply Cables

Note that this unit features two separate power circuits, that require a power supply cable for each circuit. Before attempting to service or remove this unit, please make certain that both power cables are disconnected.

FCC Part 15 Regulation

This equipment has been tested and found to comply with the limits for a Class A digital device, pursuant to Part 15 of the FCC rules. These limits are designed to provide reasonable protection against harmful interference in a residential installation. This equipment generates, uses, and can radiate radio frequency energy, and if not installed and used in accordance with the instructions, may cause harmful interference to radio communications. However, there is no guarantee that interference will not occur in a particular installation. If this equipment does cause harmful interference to radio or television reception, which can be determined by turning the equipment off and on, the user is encouraged to try to correct the interference by one or more of the following measures:

- Reorient or relocate the receiving antenna.
- Increase the separation between the equipment and receiver.
- Plug the equipment into an outlet on a circuit that is different from the one used by the receiver.
- Consult the dealer or an experienced radio/TV technician for help.

This device complies with Part 15 of the FCC rules. Operation of this device is subject to the following conditions: (1) This device may not cause harmful interference, and (2) this device must accept any interference that may cause undesired operation.

WARNING: Changes or modifications to this unit not expressly approved by the party responsible for compliance could void the user's authority to operate the equipment

EMC, Safety, and R&TTE Directive Compliance

The CE mark is affixed to this product to confirm compliance with the following European Community Directives:

- Council Directive 89/336/EEC of 3 May 1989 on the approximation of the laws of Member States relating to electromagnetic compatibility;
and
- Council Directive 73/23/EEC of 19 February 1973 on the harmonization of the laws of Member States relating to electrical equipment designed for use within certain voltage limits;
and
- Council Directive 1999/5/EC of 9 March on radio equipment and telecommunications terminal equipment and the mutual recognition of their conformity.

Industry Canada - EMI Information

This Class A digital apparatus complies with Canadian ICES-003.

Cet appareil numérique de la classe A est conforme à la norme NMB-003 du Canada.

Table of Contents

1. Introduction	1-1
2. Unit Description	2-1
3. Quick Start	3-1
3.1. Hardware Installation	3-1
3.1.1. Apply Power to the NBB	3-1
3.1.2. Connect your PC to the NBB	3-2
3.2. Communicating with the NBB	3-2
4. Installation	4-1
4.1. Power Supply Connection	4-1
4.2. Connection to Switched Outlets	4-2
4.3. Console Port Connection	4-2
4.3.1. Connecting a Local PC	4-2
4.3.2. Connecting an External Modem	4-2
4.4. Connecting the Network Cable	4-3
5. Configuration	5-1
5.1. System Mode and User Mode	5-1
5.2. Communicating with the NBB	5-2
5.2.1. Accessing the Web Browser Interface	5-3
5.2.2. Accessing the Text Interface	5-4
5.3. Configuration Menus	5-6
5.3.1. The General Parameters Menus	5-6
5.3.2. The Serial Parameters Menu	5-10
5.3.3. The Plug Parameters Menus	5-12
5.3.3.1. Plug Passwords and Co-Location Features	5-14
5.3.3.2. The Boot / Sequence Delay Period	5-15
5.3.4. Network Parameters Menus	5-16
5.3.4.1. IP Security Feature	5-18
5.3.5. The Telnet Parameters Menu	5-20
5.3.6. Web Server Parameters Menu	5-21
5.4. Save Configuration Parameters	5-22
6. Operation	6-1
6.1. Operation via the Web Browser Interface	6-1
6.1.1. The Plug Status Screen - Web Browser Interface	6-1
6.2. Operation via the Text Interface	6-3
6.2.1. The Plug Status Screen - Text Interface	6-3
6.2.2. Switching and Reboot Commands - Text Interface	6-4
6.2.3. Applying Commands to Several Plugs - Text Interface	6-6
6.3. Logging Out of Command Mode	6-7
6.4. The Automated Mode	6-7
6.5. Manual Operation	6-8
7. Saving and Restoring Configuration Parameters	7-1
7.1. Sending Parameters to a File	7-1
7.2. Restoring Saved Parameters	7-2
8. Upgrading the NBB Firmware	8-1

Appendices:

A. Interface DescriptionsApx-1
 A.1. Console Port Interface Apx-1
B. Specifications.Apx-2
C. Customer ServiceApx-3

Index..... Index-1

List of Figures

2.1. NBB-1600 Unit (120 VAC Model Shown)..... 2-1
3.1. Plug Status Screen - Web Browser Interface 3-3
3.2. Plug Status Screen - Text Interface 3-3
5.1. Plug Status Screen - Web Browser Interface (Sample Values Show)..... 5-2
5.2. Plug Status Screen - Text Interface (Sample Values Shown) 5-4
5.3. General Parameters Menu - Web Browser Interface..... 5-7
5.4. General Parameters Menu - Text Interface 5-7
5.5. Serial Parameters Menu - Web Browser Interface 5-10
5.6. Serial Parameters Menu - Text Interface 5-10
5.7. Plug Parameters Menu - Web Browser Interface 5-12
5.8. Plug Parameters Menu - Text Interface..... 5-12
5.9. Network Parameters - Web Browser Interface 5-17
5.10. Network Parameters Menu - Text Interface 5-17
5.11. IP Security Menu - Text Interface 5-18
5.12. Telnet Parameters Menu - Web Browser Interface 5-20
5.13. Telnet Parameters Menu - Text Interface 5-20
5.14. Web Browser Parameters Menu - Web Browser Interface 5-21
5.15. Web Browser Parameters Menu - Text Interface 5-21
6.1. Plug Status Menu - Web Browser Interface (Sample Values Shown)..... 6-2
6.2. Plug Status Screen - Text Interface 6-3
6.3. The NBB Help Screen - Text Interface..... 6-4
A.1. Console Port Interface..... Apx-1

1. Introduction

Electronic equipment sometimes "locks-up," requiring a service call just to flip the power switch to perform a simple reboot. The NBB-1600-D20, NBB-1600E-D20 and NBB-1600CE-D16 Network Boot Bars give you the ability to perform this function from anywhere, just point your browser to the NBB's IP address, enter the secure user name and password, and you're just a click away from remote power On, Off or Reboot!

20 Amp Power Control

The NBB D20 and D16 series Network Boot Bars provide plenty of power for rack mount applications; the NBB-1600-D20 and NBB-1600E-D20 feature two separate 20 Amp power circuits, and provide a total of 40 Amps per unit. The NBB-1600CE-D16 features two 16 Amp power circuits, for a total of 32 Amps per unit.

Intelligent Power Control

In addition to web browser access, the NBB can also communicate over any TCP/IP network using standard Telnet, or out-of-band using an external modem and basic VT100 type terminal emulation.

Security Features and Co-Location Features

To ensure security, web browser access requires the user to enter an assigned user name and password. The NBB provides two levels of operational passwords; the System Administrator Level, which allows access to all configuration and switching functions, and the User Level, which only allows access to assigned plugs and cannot be used to change unit configuration.

In addition to password security features, the NBB also includes an address specific IP security mask, which can be employed to prevent unauthorized network access to the NBB command mode.

Easy to Configure, Easy to Use

The NBB can be configured over the network, via modem, or locally via the NBB console port. Easy to use commands let you assign a location name, set system parameters and view plug status. Outlets can be switched On, Off, or booted using plug numbers or names.

Reliability and Support

The NBB is built in the USA and backed by a two year warranty. NetReach products are installed in thousands of network sites world wide. Our customers know they can depend on WTI for superior quality and reliability for their most mission-critical operations.

NBB-1600-D20, NBB-1600E-D20 and NBB-1600CE-D16 Units

This User's Guide discusses the NBB-1600-D20, NBB-1600E-D20 and NBB-1600CE-D16 Network Boot Bars. Throughout this User's Guide, all three units are referred to as the "NBB." The input voltages and maximum loads are summarized in the table below. All other features function identically except where noted.

Model Number	Total Outlets	Input Voltage	Max. Load per Outlet	Max. Load per Bus	Max. Load per Unit
NBB-1600-D20	16	100 to 120 VAC	15 Amps	20 Amps	40 Amps
NBB-1600E-D20	16	100 to 240 VAC	15 Amps	20 Amps	40 Amps
NBB-1600CE-D16	16	100 to 240 VAC	10 Amps	16 Amps	32 Amps

Typographic Conventions

Throughout this manual, typefaces and characters have been used to denote the following:

COURIER FONT Indicates characters typed on the keyboard.
For example, /**ON 3** or /**OFF 5**.

[Bold Font] Text set in bold face and enclosed in square brackets indicates a specific key.
For example, **[Enter]** or **[Esc]**.

2. Unit Description

As shown in Figure 2.1, the NBB unit includes power outlets, LEDs and a manual control button. The items shown in Figure 2.1 are described on the following page.

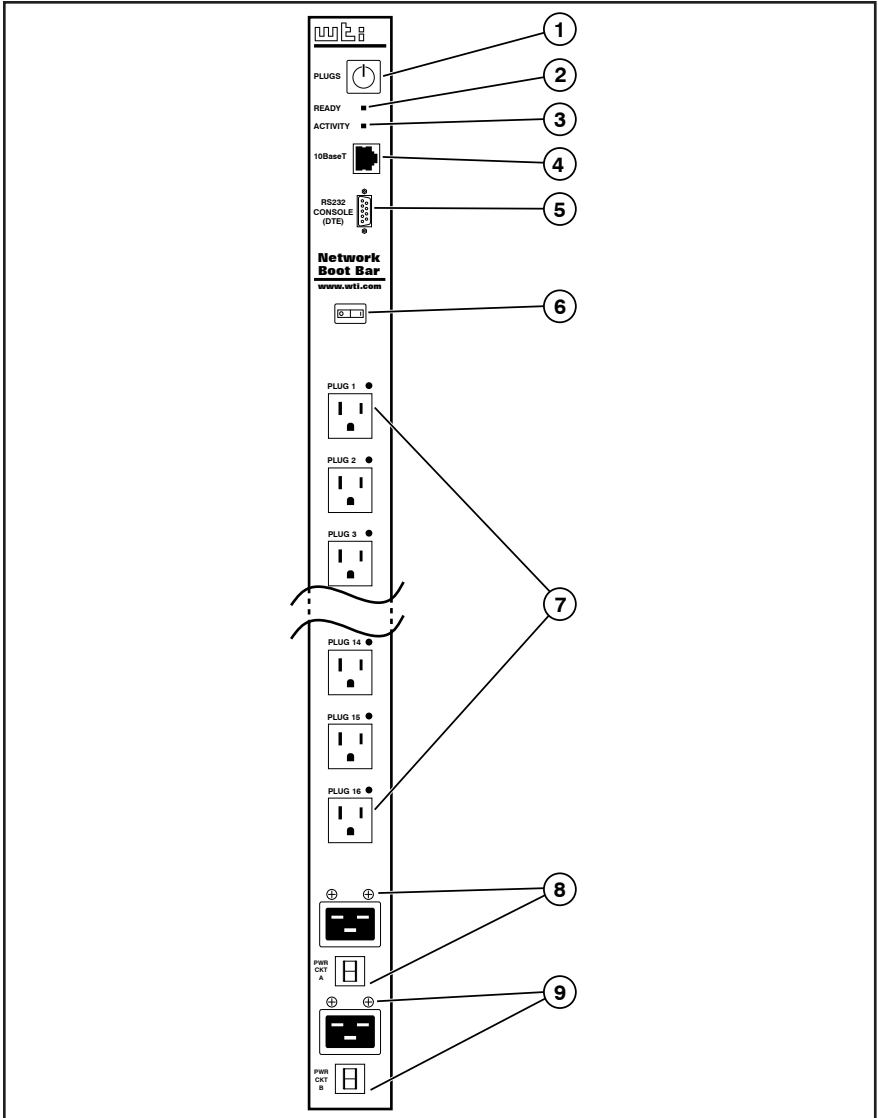

Figure 2.1: NBB-1600 Unit (120 VAC Model Shown)

- ① **Manual Switch Button:** A Manual Control Button for the unit's switched plugs. To manually switch plugs "On" or "Off", press and hold the control button for approximately three seconds. If desired, the Manual Switch Button can also be disabled (Section 5.3.1.)
Note: When the Manual Switch Button is used, Boot / Sequence Delay Times will be applied as described in Section 5.3.3.2.
- ② **Ready Indicator:** Flashes when ready to receive commands.
- ③ **Activity Indicator:** Flashes to indicate activity at the Network Port.
- ④ **10Base-T (Network) Port:** An RJ45 Ethernet Port for connection to your TCP/IP network. The default IP Address is 192.168.168.168, for more information, please refer to Section 5.3.4.
- ⑤ **RS232 Console Port:** A DB9, RS232 serial port (DTE), for connection to a local terminal or external modem, as described in Section 4.3.
- ⑥ **Master Power Switch:** This switch must be "On" in order for the NBB to function. Note that this switch is not used to set the On/Off status of the switched outlets.
- ⑦ **Switched Plugs and Plug Indicators:** For load ratings, please refer to the instrument nameplate, and the table in Section 1.
 - **Model NBB-1600-D20:** Sixteen (16) 100 to 120 VAC NEMA 5-15R outlets, split into two separate power circuits. Circuit A includes plugs 1 through 8, and Circuit B includes plugs 9 through 16.
 - **Models NBB-1600E-D20 and NBB-1600CE-D16:** Sixteen (16) 100 to 240 VAC IEC320-C13 outlets, split into two separate power circuits. Circuit A includes plugs 1 through 8, and Circuit B includes plugs 9 through 16.
- ⑧ **Power Circuit "A" Input Components:** An IEC320-C20 AC inlet and circuit breaker, which supply power to plugs one through 8. Also includes two mounting screws for Cable Keeper:
 - **Model NBB-1600-D20:** 100 to 120 VAC, 20 Amps.
 - **Model NBB-1600E-D20:** 100 to 240 VAC, 20 Amps.
 - **Model NBB-1600CE-D16:** 100 to 240 VAC, 16 Amps.

- ⑨ **Power Circuit "B" Input Components:** An IEC320-C20 AC inlet and circuit breaker, which supply power to plugs 9 through 16. Also includes two mounting screws for Cable Keeper. Includes same components as item 8 above.
- ⑩ **Rack Mounting Brackets:** (Not Shown.)

3. Quick Start

This Quick Start Guide describes a simplified installation procedure for the NBB-1600-D20, NBB-1600E-D20 and NBB-1600CE-D16 Network Boot Bars, which will allow you to communicate with the unit in order to demonstrate basic features and check for proper operation. In order to take full advantage of the complete range of features offered by this unit, it is recommended to complete the remainder of this User's Guide after performing the Quick Start Procedure.

3.1. Hardware Installation

3.1.1. Apply Power to the NBB

Refer to power rating nameplate on the NBB, and then connect the unit to an appropriate power source. Note that the NBB features two separate AC inputs and two separate power busses; connect power cables to the Circuit "A" and Circuit "B" Power Inlets, install the cable keepers as described in Section 4.1, then connect the cables to your power source. Refer to the table below for information concerning power requirements and maximum loads.

Model Number	Total Outlets	Input Voltage	Max. Load per Outlet	Max. Load per Bus	Max. Load per Unit
NBB-1600-D20	16	100 to 120 VAC	15 Amps	20 Amps	40 Amps
NBB-1600E-D20	16	100 to 240 VAC	15 Amps	20 Amps	40 Amps
NBB-1600CE-D16	16	100 to 240 VAC	10 Amps	16 Amps	32 Amps

Set the Main Power Switch in the ON position; the ON LED should light, and the RDY LED should begin to flash. This indicates that the NBB is ready to receive commands.

3.1.2. Connect your PC to the NBB

The NBB can either be controlled by a local PC, that communicates with the unit via cable, controlled via external modem, or controlled via TCP/IP network. In order to switch plugs or select parameters, commands are issued to the NBB via either the Network Port or Console Port. Note that it is not necessary to connect to both the Network and Console Ports, and that the Console Port can be connected to either a local PC or External Modem.

- **Network Port:** Connect your 10Base-T or 100Base-T network interface to the NBB Network (10Base-T) port.
- **Console Port:** Use the supplied null modem cable to connect your PC COM port to the NBB COM (RS232) Port.
- **External Modem:** Use a standard AT to Modem cable to connect your external modem to the NBB COM (RS232) Port.

Note that when the NBB is shipped from the factory, RS232 Port Parameters are set as follows: 9600 bps, 8 Data Bits, One Stop Bit, No Parity. Although the NBB allows these parameters to be easily redefined, for the purpose of this Quick Start procedure, it is recommended to configure your communications program to accept these default parameters.

3.2. Communicating with the NBB

The NBB offers two separate user interfaces: the Web Browser Interface and the Text Interface. The Web Browser interface allows you to contact the NBB via TCP/IP network, using a standard, JavaScript enabled web browser (such as Internet Explorer.) The Text Interface consists of a series of ASCII text menus, which may be accessed via TCP/IP network, Local PC or modem.

Note: The NBB features a default IP Address (192.168.168.168) and default Subnet Mask (255.255.255.0). This allows network access to command mode without first setting up the unit's network parameters (providing you are contacting the NBB from a node on the same subnet.) When attempting to access the NBB from a node that is not on the same subnet, please refer to Section 5.3.4 for further configuration instructions.

1. **Access the Command Mode:** This procedure differs slightly, depending on whether you're contacting the NBB via the Web Browser Interface or Text Interface.
 - a) **Web Browser Interface:** Start your Web Browser. Enter the NBB's default IP address (192.168.168.168) in your browser address bar and press **[Enter]**. A password prompt will be displayed. Since at this point, the user name and password have not yet been defined, you can simply click OK in response to the prompt. The Plug Status Screen will be displayed as shown in Figure 3.1.

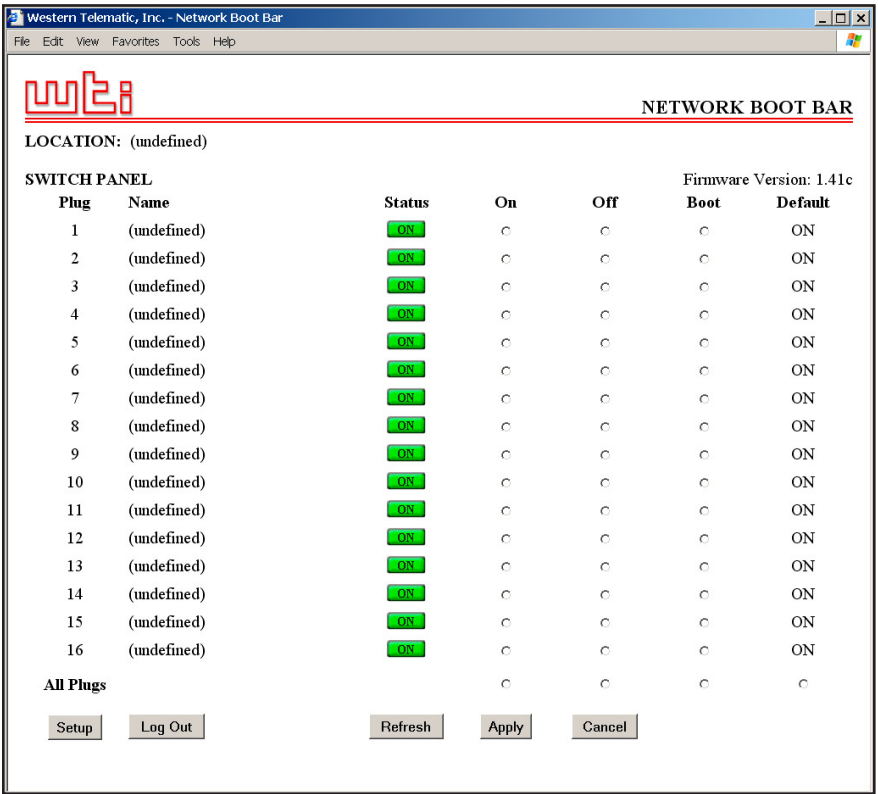

Figure 3.1: Plug Status Screen - Web Browser Interface

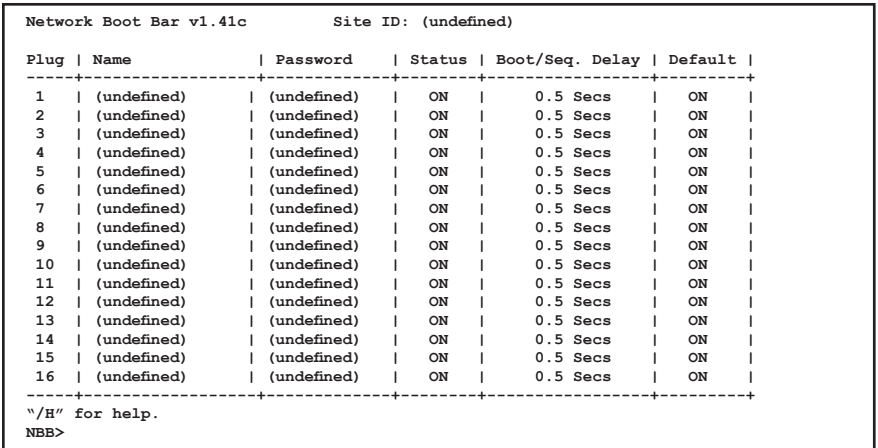

Figure 3.2: Plug Status Screen - Text Interface

- b) **Text Interface:**
 - i. **Via Telnet:** Telnet to the default IP address (192.168.168.168). The Plug Status Screen (Figure 3.2) should be displayed.
 - ii. **Via Local PC:** Start your communications program (e.g., Hyperterminal) and press **[Enter]**. The Plug Status Screen should be displayed (Figure 3.2.) The default parameters for the Console Port are 9600 bps, No Parity, 8 data bits, One stop bit.
 - iii. **Via Modem:** Use your communications program to dial the number for the phone line connected to your external modem. In order to communicate with the unit via modem, you must first access the command mode via Network or Local PC, and use the Serial Parameters Menu to set the Port Mode to "Modem."
- 2. **Test Switching Functions:** You may wish to perform the following tests in order to make certain that the NBB is responding to commands.
 - a) **Reboot Outlet:** If you are communicating with the unit via the Web Browser Interface, select the button in the "Boot" column for Plug 1, and then click on "Apply." If you are operating the unit via the Text interface, type **/BOOT 1** and press **[Enter]**. The status indicator for Plug 1 should go off, pause for a moment, and then go back on, indicating that the boot cycle has been successfully completed.
 - b) **Switch Outlet Off:** From the Web Browser Interface, select the button in the "Off" column for Plug 1, and then click "Apply." From the Text Interface, type **/OFF 1** and press **[Enter]**. The status indicator for Plug 1 should go Off, indicating that the command has been successfully completed. Leave Plug 1 in the "Off" state, and then proceed to the next step.
 - c) **Switch Outlet On:** From the Web Browser Interface, select the button in the "On" column for Plug 1, and then click "Apply." From the Text Interface, type **/ON 1** and press **[Enter]**. The status indicator for Plug 1 should then go back On, indicating that the command has been successfully completed.

3. **Log Out:** When you have finished communicating with the unit it is important to always log off by issuing the appropriate NBB command, rather than simply closing your Telnet or communications program. When you log off using the proper NBB command, this ensures that the unit has completely exited from command mode, and is not waiting for the inactivity timeout to elapse before allowing additional connections.
 - a) **Web Browser Interface:** Click on the "Log Out" button.
 - b) **Text Interface:** Type **/x** and press **[Enter]**.

This completes the Quick Start Guide for the NBB. Prior to placing the unit into operation, it is recommended to refer to the remainder of this User's Guide for important information regarding advanced configuration capabilities and more detailed operation instructions. If you have further questions regarding the NBB unit, please contact WTI Customer Support as described Appendix C.

4. Installation

This section provides further details regarding the connections that are made in the process of installing the NBB.

4.1. Power Supply Connection

Connect the NBB unit to an appropriate power supply. The NBB's Master Power Switch must be "On" in order for the unit to operate.

To install the supplied "Cable Keepers", first, make certain that both power cables are disconnected from your power supply. Next, loosen (but do not remove) the two Phillips head screws located directly above each power inlet. Connect the power supply cables to the NBB's power inlets, then slip the Cable Keepers over each supply cable, so the notch on the top of each keeper secures each cable, and the two slots on the bottom of each keeper slide over the loosened screws. Tighten the Phillips head screws to secure each cable keeper to the unit, make certain the cables are secure, and then connect the cables to your power supply.



- **This device should only be operated with the type of power source indicated on the instrument nameplate. If you are not sure of the type of power service available, please contact your local power company.**
- **Reliable earthing (grounding) of this unit must be maintained. Particular attention should be given to supply connections when connecting to power strips, rather than directly to the branch circuit.**
- **Check nameplate ratings to ensure that there is no overloading of supply circuits that could have an effect on overcurrent protection and supply wiring.**

4.2. Connection to Switched Outlets

Connect the power cord from your switched device to one of the AC Outlets on the IPS unit. Note that when power is applied to the IPS, the AC Outlets will be switched "ON" by default.

- **NBB-1600-D20:** 100 to 120 VAC. Includes two separate power busses. Each bus can support a total of 20 Amps. Each AC Outlet can support up to 15 Amps.
- **NBB-1600E-D20:** 100 to 240 VAC. Includes two separate power busses. Each bus can support a total of 20 Amps. Each AC Outlet can support up to 15 Amps.
- **NBB-1600CE-D16:** 100 to 240 VAC. Includes two separate power busses. Each bus can support a total of 16 Amps. Each AC Outlet can support up to 10 Amps.

4.3. Console Port Connection

The Console Port is a male, RS232C DB9 connector, wired in a DTE configuration similar to an AT computer. In the default state, the Console port is configured for 9600 bps, no parity, 8 data bits, 1 stop bit. The Console Port can be connected to either an external modem or a local PC, but not both items at the same time. Appendix A describes the Console Port interface.

4.3.1. Connecting a Local PC

When connecting the Console Port to a Local PC, note that the port uses a DTE configuration. After the Local PC has been connected, make certain to set the Serial Port Mode to "Console" as described in Section 5.3.2.

4.3.2. Connecting an External Modem

When connecting directly to an external modem, use a standard AT Style to Modem cable. Make certain that the modem is initialized to the same default communications parameters as the NBB Console Port. Next, refer to Section 5.3.2 and set the Serial Port Mode to "Modem". If necessary, you may also wish to redefine the Modem initialization command at this point as described in Section 5.3.2. Please refer to the modem user's guide for more information.

4.4. Connecting the Network Cable

The Network Port is an RJ45 Ethernet jack, for connection to a TCP/IP network. Connect your 10Base-T cable to the Network Port. Note that the NBB includes a default IP address (192.168.168.168) and a default subnet mask (255.255.255.0.) When installing the NBB in a working network environment, it is recommended to define network parameters as described in Section 5.3.4.

Note: The NBB features a 10Base-T Interface. When connecting to a 100Base-T interface, most router switches will autosense to determine if the device is 100Base-T or 10Base-T, and then configure the network interface accordingly. If your router switch does not autosense, the network interface port must be manually set to 10Base-T.

This completes the NBB installation instructions. Please proceed to the next Section for instructions regarding unit configuration.

5. Configuration

5.1. System Mode and User Mode

In order to restrict access to sensitive command functions, the NBB features two operating modes; System Mode and User Mode.

- **System Mode:** Allows access to all configuration menus, switching functions and status screens. The System Mode Status Screens show On/Off conditions for all switched outlets, and list all currently defined system parameters.
- **User Mode:** Allows access to status screens and On/Off/Boot commands, but does not allow access to configuration functions. Users may only issue commands to, or view status of the plugs that are specifically allowed by their password.

The NBB will display a password prompt when the unit is contacted via the Console Port or Network Port. The password entered at this prompt determines whether the unit will start-up in System Mode or User Mode. If the System Password is entered, the System Mode will be active. If a Plug Password is entered, the User Mode will be active. The System Password is defined via the General Parameters menu (Section 5.3.1), and the Plug Passwords are defined via the Plug Parameters Menu (Section 5.3.3.)

Notes:

- If you wish to restrict access to configuration menus, you must define the System Password.
- If the System Password is not defined, the NBB will always start-up in System Mode.
- If the System Password is not defined, the Password Prompt will not be displayed when you access the NBB via the Text Interface. The prompt will always be displayed when the NBB is contacted via the Web Browser Interface.
- When the NBB is contacted via Network, the password prompt will also include a field for the user name. If you have *not* defined a user name, then you may leave this field blank, and only the password is required to gain access to the unit. The user name prompt is not displayed when the unit is contacted via the Text Interface.

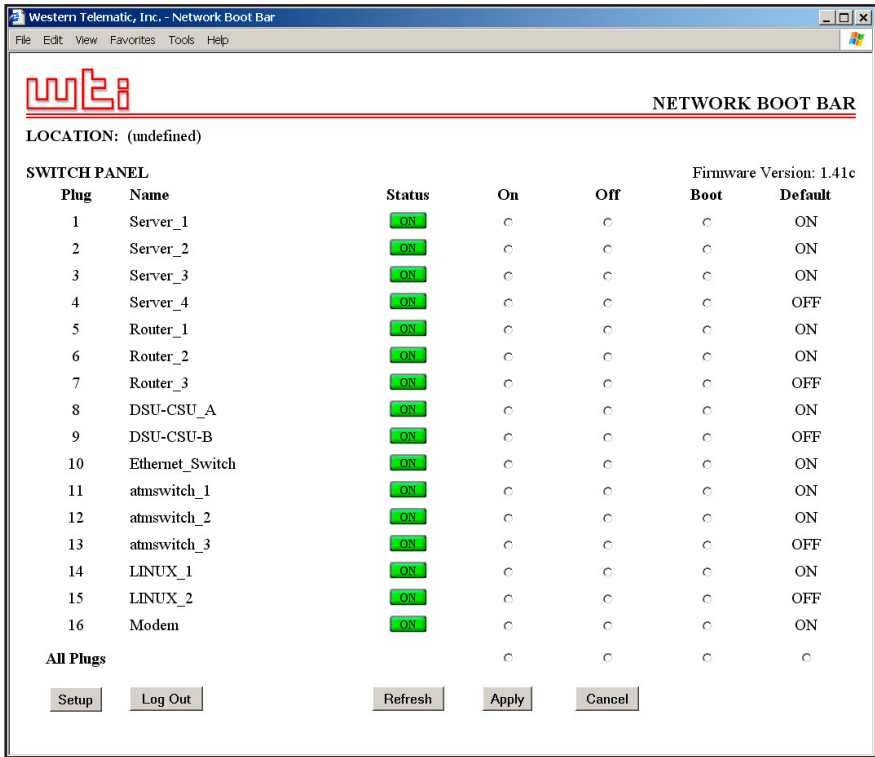

Figure 5.1: Plug Status Screen - Web Browser Interface (Sample Values Show)

5.2. Communicating with the NBB

In order to configure the unit or invoke command functions, you must first connect to the NBB and access the command mode. As discussed in Section 3, the NBB offers two separate command interfaces: the Web Browser Interface, and the Text Interface.

The NBB also offers three different methods for accessing command mode; via network, via external modem, or via local console. The Web Browser Interface is only available when the NBB is contacted via network, and the Text Interface is available via network, modem or local PC. The sections that follow describe the procedure for accessing the Web Browser Interface or the Text Interface.

Note: Configuration functions are only available when you have logged into command mode using the System Password.

5.2.1. Accessing the Web Browser Interface

In order to issue commands via the Web Browser Interface, the NBB must be connected to a TCP/IP network, and your PC must be equipped with a JavaScript enabled web browser (such as Internet Explorer or Netscape Navigator.)

1. Start your JavaScript enabled Web Browser.
2. Key the NBB's IP address (default = http://192.168.168.168) into the web browser's address bar, and then press **[Enter]**.
3. **Password Prompt:** The NBB will display a prompt, which asks for your name and password.
 - a) **User Name:** If you have not previously defined a user name, then this field should be left blank. A user name is only required when one has been defined via the General Parameters menu.
 - b) **Password:** Key in your System Password or Plug Password and then click "OK" (Note that Plug Passwords do not permit access to configuration functions.)
 - c) If the System Password has *not* been defined, simply click the "OK" button without keying in a name or password.

If a valid password is entered, the Plug Status Screen (Figure 5.1) will appear.

```

Network Boot Bar v1.41c           Site ID: (undefined)

Plug | Name           | Password | Status | Boot/Seq. Delay | Default |
-----+-----+-----+-----+-----+-----+
 1 | Server_1       | (defined) | ON | 15 Secs | ON |
 2 | Server_2       | (defined) | ON | 15 Secs | ON |
 3 | Server_3       | (defined) | ON | 15 Secs | ON |
 4 | Server_4       | (defined) | ON | 15 Secs | OFF |
 5 | Router_1       | (defined) | ON | 0.5 Secs | ON |
 6 | Router_2       | (defined) | ON | 0.5 Secs | ON |
 7 | Router_3       | (defined) | ON | 0.5 Secs | OFF |
 8 | DSU-CSU_A      | (defined) | ON | 1 Sec | ON |
 9 | DSU-CSU-B      | (defined) | ON | 1 Sec | OFF |
10 | Ethernet_Switch | (defined) | ON | 0.5 Secs | ON |
11 | atmswitch_1    | (defined) | ON | 2 Secs | ON |
12 | atmswitch_2    | (defined) | ON | 2 Secs | ON |
13 | atmswitch_3    | (defined) | ON | 2 Secs | OFF |
14 | LINUX_1        | (defined) | ON | 5 Secs | ON |
15 | LINUX_2        | (defined) | ON | 5 Secs | OFF |
16 | Modem          | (defined) | ON | 30 Secs | ON |
-----+-----+-----+-----+-----+
"/H" for help.

NBB>
    
```

Figure 5.2: Plug Status Screen - Text Interface (Sample Values Shown)

5.2.2. Accessing the Text Interface

The Text Interface can be accessed via Network, modem or local PC. In order to access the Text Interface, your installation must include the following:

- **Access Via Network:** The NBB must be connected to your TCP/IP Network, and your PC must include a communications program (such as Hyperterminal™.)
- **Access Via Modem:** An external modem must be connected to the NBB's Console Port, and a phone line must be connected to the external modem. Your PC Must include a communications program.
- **Access Via Local PC:** Your local PC Must be connected to the NBB's Console Port. The local PC must include a communications program.

To access command mode via the Text Interface, proceed as follows:

1. The NBB is transparent to parity and will accept 7 or 8 bit characters, but will always answer back at 8 bits, no parity. Make certain your communication program is set for the appropriate baud rate, bits, parity and Comm Port.
 - a) **Via Modem:** Start your communications program. Dial the external modem connected to the NBB. Wait for the Connect message, then proceed to Step 2.
 - b) **Via Local PC:** Start your communications program and press [Enter]. Wait for the connect message, then proceed to Step 2.

-
- c) **Via Network:** The NBB includes a default IP address (192.168.168.168), which allows you to contact the unit from any network node on the same subnet. When the NBB is installed in a working network environment, it is recommended that you redefine the IP Address, Subnet Mask, and Gateway Address as described in Section 5.3.4.
- i. Telnet to the NBB's IP address. For example, if the IP address is "192.168.168.168", then on a UNIX system, the Telnet command would be:

```
$ telnet 192.168.168.168 [Enter]
```
 - ii. If the Telnet connection is refused, this may mean that either the IP Security feature has denied the connection (See Section 5.3.4.1), or that unit is operating on a 100Base-T network that does not autosense for 10Base-T devices (see Section 4.4.)
2. **Password:** If the System Password has been defined, the unit will display the Password Prompt. Key in either the System Password or Plug Password, and press **[Enter]**. If the System Password has *not* been defined, the prompt will not be displayed when the unit is accessed via the Text Interface. Note that the Password feature is case sensitive.
3. If a valid System Password or Plug Password is entered, the NBB will display the Plug Status Screen shown in Figure 5.2, followed by the "NBB>" Command Prompt.

Note: The Plug Status Screen will not display actual passwords. The password column will read either "defined" or "undefined", depending upon whether or not the System Password or Plug Passwords have been defined.

5.3. Configuration Menus

As described in the sections that follow, configuration parameters for the NBB can be selected via the Web Browser Interface or Text Interface. Although the Web Browser and Text Interface provide two separate means for selecting parameters, both interfaces allow access to essentially the same set of parameters, and parameters selected via one interface will also be applied to the other.

Web Browser Interface: Click the "Setup" button to gain access to the configuration menus; a row of buttons will be displayed along the left hand edge of the screen. Click the appropriate button to access the desired menu. Note the following:

- Newly selected parameters will not be activated until you click the "Apply" button.
- Click "Switch Panel" to return to the main status screen.

Text Interface: Refer to the Help Screen (**/H**) and then enter the appropriate command to access the desired menu. When the configuration menu appears, key in the number or letter for the parameter that you wish to define and follow the instructions in the resulting submenu. Note the following:

- To exit from a parameters menu, press the **[Esc]** key.

The following sections describe the options and parameters that can be accessed via each of the configuration menus. Please note that essentially the same selection of parameters and options are available via both the Web Browser Interface and Text Interface.

Note: Configuration menus are only available when the System Mode is active. Configuration menus are not available if you have logged in using a Plug Password.

5.3.1. The General Parameters Menus

The General Parameters Menus allow you to select parameters such as the System Password, User Name, Site I.D., Modem Commands and other options.

- **Web Browser Interface:** Click the "Setup" button to access the Setup Menus, and then click the "General Parameters" button. The General Parameters Menu will be displayed as shown in Figure 5.3.
- **Text Interface:** Type **/G** and press **[Enter]**. The General Parameters Menu will be displayed as shown in Figure 5.4.

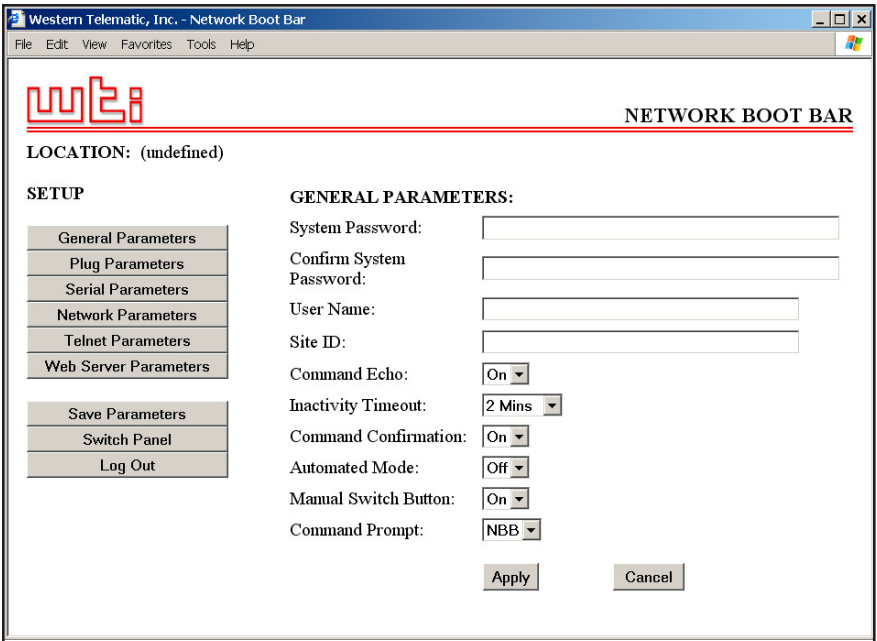

Figure 5.3: General Parameters Menu - Web Browser Interface

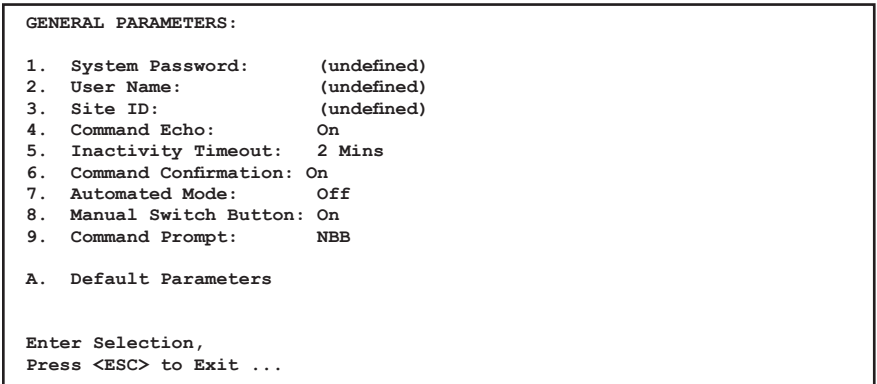

Figure 5.4: General Parameters Menu - Text Interface

The General Parameters Menu allows the following parameters to be defined.

- **System Password:** The NBB will display a password prompt when you attempt to access command mode. When the System Password is entered at log on, the System Mode will be active, allowing access to both switching functions and configuration menus. (16 Characters, Default = undefined.)

Notes:

- If the System Password is *not* defined, then the NBB will start up in System Mode, and configuration functions will then be available to anyone who accesses Command Mode.
- Passwords and User Names cannot contain nonprintable characters, spaces, colons (:), plus signs (+) or quotation marks.
- **User Name:** (Optional) The User Name allows you to set up an additional layer of security for web access to the command mode by requiring that users correctly enter a name in addition to a password. Note that the User Name is only required when the unit is accessed via the Web Interface. (16 Characters, Default = undefined.)

Notes:

- If a User Name is defined, then users who log in with a Plug Password (User Mode) will also need to enter this same User Name at the login prompt when attempting to access command mode via the Web Browser Interface.
- The User Name cannot begin with a forward slash (/) or backslash (\) character, and cannot include non-printable characters, space characters, asterisks (*) or quotation marks.
- **Site ID:** Defines a brief text message, which can be used to describe the location of the NBB unit. (Up to 32 characters, Default = undefined.)

Note: The Site ID Message cannot begin with a forward slash (/) or backslash (\) character and cannot include non-printable characters or quotation marks.

- **Command Echo:** Enables/Disables command echo. When enabled, ASCII commands sent via the Text Interface to the NBB will be echoed back, allowing keystrokes to be displayed. Note that this feature applies primarily to the text interface, and has no visible effect on the Web Browser Interface. (Default = On.)

- **Inactivity Timeout:** Determines how long the NBB will wait for additional commands during periods of inactivity. When the Timeout Period elapses, the user will be disconnected from the NBB command mode. (Default = 2 Minutes.)
- **Command Confirmation:** When enabled, the NBB will display a confirmation prompt before executing certain commands. When disabled, the prompt will be suppressed and commands will be executed immediately. (Default = On/Enabled.)
- **Automated Mode:** When enabled, the NBB will execute switching, reboot and exit commands without displaying a confirmation prompt, status screen or confirmation messages. This allows the NBB to be controlled by a device that generates commands to control switching without human intervention. For more information, please refer to Section 6.4. (Default = Off.)

Note: When this option is enabled, security functions are suppressed, and users are able to access System Level menus and control plugs without entering a password. If security is a concern and the Automated Mode is required, it is recommended to use the IP Security feature (Section 5.3.4.1) to restrict access.

- **Manual Switch Button:** Enables and configures the manual plug control button. (Default = "On".)
 - **Off:** Disables the manual switch button.
 - **On:** Enables the manual switch button. When the manual switch button is pressed and held for approximately three seconds, all sixteen outlets will be effected.
- **Command Prompt:** Allows the Text Interface command prompt to be set to either "NBB", "IPS", or "NPS." (Default = NBB.)
- **Default Parameters:** Resets the NBB to default parameters. All menu selected parameters, including port names and passwords, will be cleared. This option is only available via the Text Interface.

Note: If this function is invoked via the Network Port, the IP Address will *not* be reset until you break your connection to the Network Port. If this function is invoked via the Console Port, the IP Address will be reset immediately.

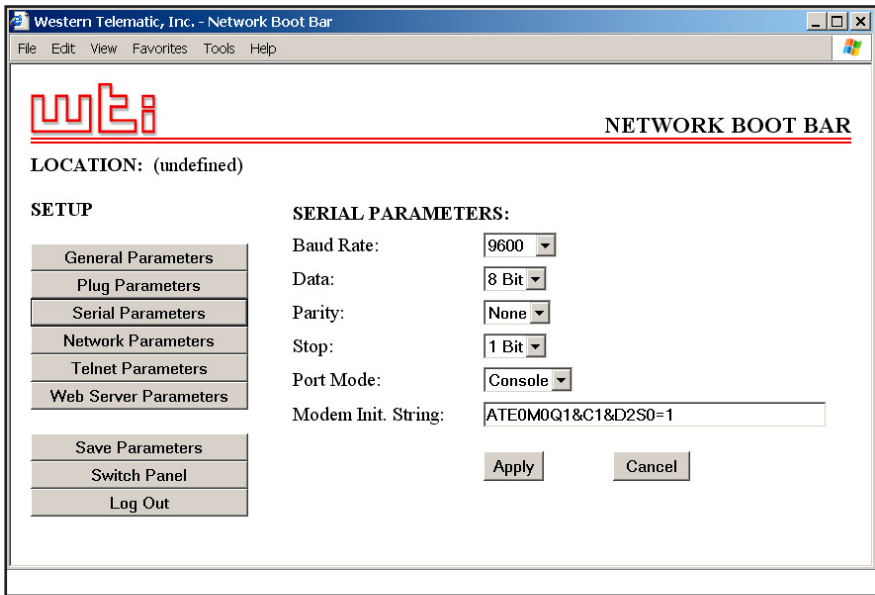

Figure 5.5: Serial Parameters Menu - Web Browser Interface

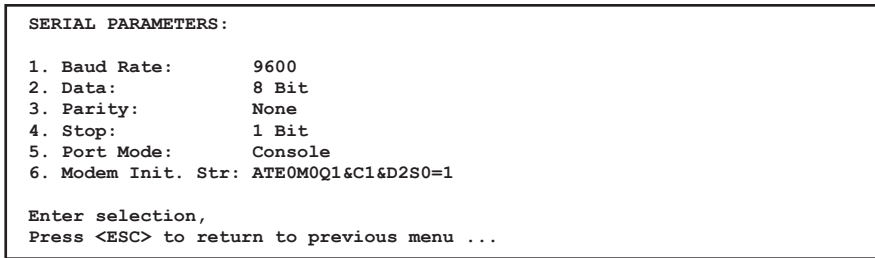

Figure 5.6: Serial Parameters Menu - Text Interface

5.3.2. The Serial Parameters Menu

The Serial Parameters Menus are used to configure the NBB's serial console port, and allow you to select parameters such as the baud rate, parity and modem initialization string. To access the Serial Parameters Menus, proceed as follows:

- **Web Browser Interface:** Click the "Setup" button to access the Setup Menus, and then click the "Serial Parameters" button. The Serial Parameters Menu will be displayed as shown in Figure 5.5.
- **Text Interface:** Type `/C` and press **[Enter]**. The Serial Parameters Menu will be displayed as shown in Figure 5.6.

As shown in Figure 5.5 and Figure 5.6, the Serial Parameters Menus allow you to define the following parameters:

Note: When the baud rate, data bits, parity or stop bits settings are changed via the console port, newly selected parameters will not be applied until the user exits and then re-enters command mode.

- **Baud Rate:** The Baud Rate for the serial Console Port. (Default = 9600 bps.)
- **Data:** The Data bits setting for the serial Console Port. (Default = 8 Bits.)
- **Parity:** The parity setting for the serial Console Port. (Default = None.)
- **Stop:** The stop bits setting for the serial Console Port. (Default = 1 Bit.)
- **Serial Port Mode:** Sets up the NBB Console Port for use with either a local PC ("Console") or an external modem ("Modem"). Note that when the Serial Port Mode is set to "Modem" the modem initialization string will be sent every 15 minutes. (Default = Console.)
- **Modem Initialization String:** Defines a command string (up to 32 characters long) which can be sent out the serial Console Port to initialize an external modem. If the Serial Port Mode is set to "Console", the modem initialization string will not be sent. For more information on initialization commands, refer to the user's guide for your modem. (Default = **ATE0MOQ1&C1&D2S0=1**)

Note: The Modem Initialization String cannot begin with a forward slash (/) or backslash (\) character, and cannot include non-printable characters or quotation marks.

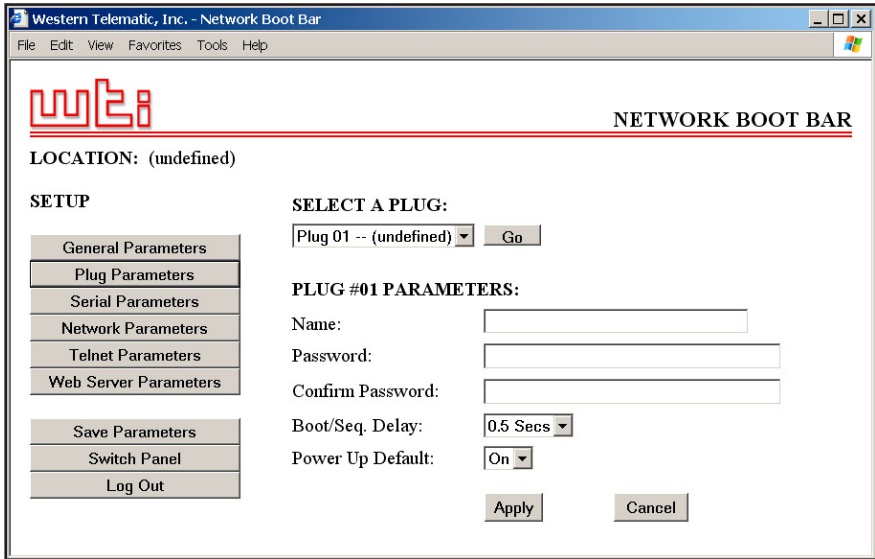

Figure 5.7: Plug Parameters Menu - Web Browser Interface

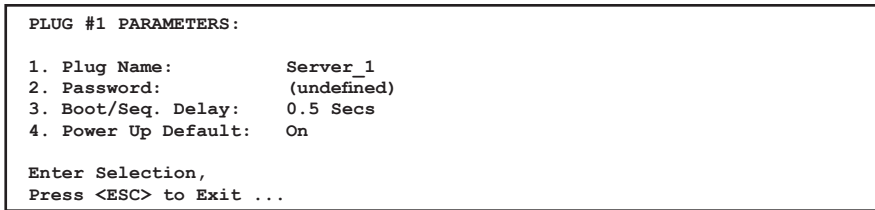

Figure 5.8: Plug Parameters Menu - Text Interface

5.3.3. The Plug Parameters Menus

The Plug Parameters Menus are used to define Plug Names, Plug Passwords, boot/sequence delay times and Power Up Default values for each of the NBB's Switched AC Outlets.

- **Web Browser Interface:** Click the "Setup" button to access the configuration menus, then click the "Plug Parameters" button. The Plug Parameters Menu will be displayed as shown in Figure 5.7.
- **Text Interface:** Type `/P n` and then press **[Enter]** (Where `n` is the number or name of the plug you wish to configure.) The Plug Parameters Menu will be displayed as shown in Figure 5.8.

Note that when defining plug parameters via the Web Browser Interface, the desired plug is selected using the dropdown menu at the top of the page. When defining plug parameters via the Text Interface, the plug is selected using the `/P n` command (where `n` is the number or name of the desired plug.)

The Plug Parameters Menu allows the following parameters to be defined:

- **Plug Name:** Assigns a name to the plug. (Up to 32 Characters, Default = undefined.)
Note: The Plug name cannot begin with a number, the underscore character (`_`), the slash character (`/`) or an asterisk (`*`).
- **Plug Password:** Assigns a password to the corresponding plug. When this password is entered at login, the user will be able to issue commands to this plug, and any other NBB plug that shares the same password as described in Section 5.3.3.1 below. Note that this password does not allow access to configuration functions. (16 Characters, Default = undefined.)
Note: Passwords cannot contain nonprintable characters, spaces, colons (`:`), plus signs (`+`) or quotation marks.
- **Boot/Seq. Delay:** When more than one plug is switched On/Off or a reboot cycle is initiated, the Boot/Sequence delay determines how much time will elapse between switching operations, as described in Section 5.3.3.2. (Default = 0.5 Seconds.)
- **Power Up Default:** Determines how this plug will react when the Default command (`/D`) is invoked, or after power to the unit has been interrupted and restored. When the Default command is invoked, or power is restored, the NBB will automatically switch each plug On or Off as specified by the Power-Up Default. (Default = On.)
Note: If you have accessed command mode using the System password, the Default command will apply to all sixteen switched plugs. If you have accessed command mode using a plug password, then the command will only be applied to plugs that share the same password entered at login.

5.3.3.1. Plug Passwords and Co-Location Features

The Plug Passwords, which are defined via the Plug Parameters Menu(s) allow you to determine which plugs an individual user will be permitted to control. When a plug password is entered while logging into command mode, the user will be able to issue switching and reboot commands for the corresponding plug, and every other plug that shares this same password.

For example, if the plug password "switch" is defined for plugs 1, 2, and three, then if a user logs into command mode using the password "switch", that user will be allowed to issue switching and reboot commands to plugs 1, 2, and 3, but not plugs 4 through 16.

Note that the Plug Passwords do not allow access to configuration functions, and users are only allowed to view the status of the plugs that are permitted by their password.

5.3.3.2. The Boot / Sequence Delay Period.

The Boot / Sequence Delay value will be applied differently for Reboot operations as opposed to simple On/Off operations as described below:

1. **Reboot Cycles:**
 - a) **Single Plug:** The Boot/Seq. Delay determines how long the plug will remain Off before it is switched back On again.
 - b) **Several Plugs:** The Boot/Seq. Delay determines how long the plug will remain in the "Off" condition, and also how long the NBB will pause before proceeding to the next plug specified.
2. **On/Off Switching:** The Boot/Seq. Delay determines how long the NBB will pause before proceeding to the next plug specified by the ON command.

Examples: Assume that the Boot / Sequence Delays for each plug have been set as follows: Plug 1 = 1 Second, Plug 2 = 2 Seconds, Plug 3 = 5 Seconds, Plug 4 = 1 Minute, Plug 5 = 1 Second

If an "On" command is applied to the first five plugs, the NBB will respond as follows:

1. Turn On Plug 1, Wait 1 Second.
2. Turn On Plug 2, Wait 2 Seconds
3. Turn On Plug 3, Wait 5 Seconds
4. Turn On Plug 4, Wait 1 Minute
5. Turn On Plug 5

If a "Reboot" Command is applied to Plug 3, the NBB will respond as follows:

1. Turn Off Plug 3, Wait 5 Seconds, Turn On Plug 3.

If a Reboot Command is applied to the first five plugs, the NBB will respond as follows:

1. Turn Off the first five plugs (short delay between plugs.)
2. Wait 1 Second, Turn On Plug 1, Wait 1 Second.
3. Wait 2 Seconds, Turn On Plug 2, Wait 2 Seconds.
4. Wait 5 Seconds, Turn On Plug 3, Wait 5 Seconds.
5. Wait 1 Minute, Turn on Plug 4, Wait 1 Minute.
6. Wait 1 Second, Turn on Plug 5.

5.3.4. Network Parameters Menus

The Network Parameters Menus are used to select the IP Address and other network parameters.

- **Web Browser Interface:** Click the "Setup" button to access the Setup Menus, and then click the "Network Parameters" button. The Web Parameters Menu will be displayed as shown in Figure 5.9.
- **Text Interface:** Type **/N** and press **[Enter]**. The Network Parameters Menu will be displayed as shown in Figure 5.10.

Notes:

- Although the Web Browser Interface and Text Interface both allow configuration of the same network parameters, note that for the Text Interface, the IP Security feature is configured via a separate submenu. For more information on IP Security, please refer to Section 5.3.4.1.
- Settings for network parameters depend on the configuration of your individual network. Contact your network administrator for appropriate settings.

The Network Parameters Menu allows the following parameters to be defined. Except where noted, all parameters listed here are available via both the Web Browser Interface and the Text Interface.

- **IP Address:** Defines the IP address for the NBB unit. (Default = 192.168.168.168.)
- **Subnet Mask:** Defines the Subnet Mask for the NBB unit. (Default = 255.255.255.0.)
- **Gateway Address:** Defines the Gateway Address for the NBB unit. (Default = undefined.)
- **Send MSS:** Defines the Maximum Segment Size that will be sent by the NBB. (Default = 536.)
- **IP Security:** Please refer to Section 5.3.4.1 for a detailed description of the IP Security feature.
- **MAC Address:** Displays the unit's MAC Address. Please note that this item only displays the assigned MAC Address, and cannot be used to redefine the address.

Notes:

- To display the Network Status Screen, type **/SN** and press **[Enter]**.
- To reset the Network Port, type **/R** and press **[Enter]**.

Western Telematic, Inc. - Network Boot Bar

File Edit View Favorites Tools Help

wte NETWORK BOOT BAR

LOCATION: (undefined)

SETUP

- General Parameters
- Plug Parameters
- Serial Parameters
- Network Parameters
- Telnet Parameters
- Web Server Parameters

Save Parameters
Switch Panel
Log Out

NETWORK PARAMETERS:

IP Address:

Subnet Mask:

Gateway Address:

Send MSS:

Security #1

Mask:

Action:

Security #2

Mask:

Action:

Security #3

Mask:

Action:

Security #4

Mask:

Action:

Security #5

Mask:

Action:

Figure 5.9: Network Parameters - Web Browser Interface

```

NETWORK PARAMETERS :

1. IP Address:          207.212.30.80
2. Subnet Mask:        255.255.255.0
3. Gateway Address:    207.212.30.1
4. Send MSS:           536
5. IP Security

MAC Address:           00-09-9b-00-9b-82

Enter Selection,
Press <ESC> to Exit ...
    
```

Figure 5.10: Network Parameters Menu - Text Interface

```
IP SECURITY:

1. Security Mask #1: (undefined)
2. Mask #1 Action: Permit
3. Security Mask #2: (undefined)
4. Mask #2 Action: Permit
5. Security Mask #3: (undefined)
6. Mask #3 Action: Permit
7. Security Mask #4: (undefined)
8. Mask #4 Action: Permit
9. Security Mask #5: (undefined)
10. Mask #5 Action: Permit

Enter Selection or <ESC> to Exit ...
```

Figure 5.11: IP Security Menu - Text Interface

5.3.4.1. IP Security Feature

The IP Security feature can be used to restrict unauthorized IP addresses from establishing a connection with the NBB. In the default state, the NBB accepts incoming IP connections from all hosts. To configure the IP Security feature, proceed as follows:

1. Access the IP Security Menu:
 - a) **Web Browser Interface:** The IP Security feature is configured using the fields at the bottom of the Network Parameters Menu as shown in Figure 5.9.
 - b) **Text Interface:** Go to the Network Parameters menu (**/N**), type **5** and press **[Enter]**. The IP Security menu will be displayed as shown in Figure 5.11.
2. The IP Security menu lists five IP Security "masks" along with the selected permit/deny action for each mask.
 - a) Each Security Mask prompt defines a specific IP address or range of addresses. Each Mask Action prompt defines the permit/deny action for the corresponding mask.
 - b) Masks are listed in order of ascending priority; Mask 1 has the lowest priority, Mask 5 has the highest priority.
 - c) Masks have a cumulative effect; high priority masks supersede the effect of lower priority masks.
 - d) Each IP Address consists of a series of four eight bit numbers. The number 255 is used as a wild card.

Example 1: Deny access to all hosts except 192.1.1.5:

Security Mask #1: 255.255.255.255	Mask #1 Action: Deny
Security Mask #2: 192.1.1.5	Mask #2 Action: Permit

Since 255 is a wild card, Mask #1 blocks all IP Addresses. Mask #2 then specifically grants access to 192.1.1.5 only.

Example 2: Allow access only by addresses that begin with 192.

Security Mask #1: 255.255.255.255	Mask #1 Action: Deny
Security Mask #2: 192.255.255.255	Mask #2 Action: Permit

Since 255 is a wild card, Mask 1 blocks all IP addresses. Mask 2 then grants access to all addresses that begin with 192.

Example 3: Allow access only by addresses that begin with 192, deny access to 192.1.1.5.

Security Mask #1: 255.255.255.255	Mask #1 Action: Deny
Security Mask #2: 192.255.255.255	Mask #2 Action: Permit
Security Mask #3: 192.1.1.5	Mask #3 Action: Deny

Since 255 is a wild card, Mask 1 blocks all IP addresses. Mask 2 then grants access to all addresses that begin with 192. Finally, Mask 3 specifically blocks access by 192.1.1.5.

Note:

- Mask #5 has priority over the other four masks. If Mask #5 is set to deny access by "255.255.255.255" (all wild cards), you will not be able to access NBB Command Mode via network. Access will only be allowed via a Local PC or external modem connected to the NBB Console Port.
- When using the wild card address "255.255.255.255", make certain that at least one higher priority mask permits access by your IP address.

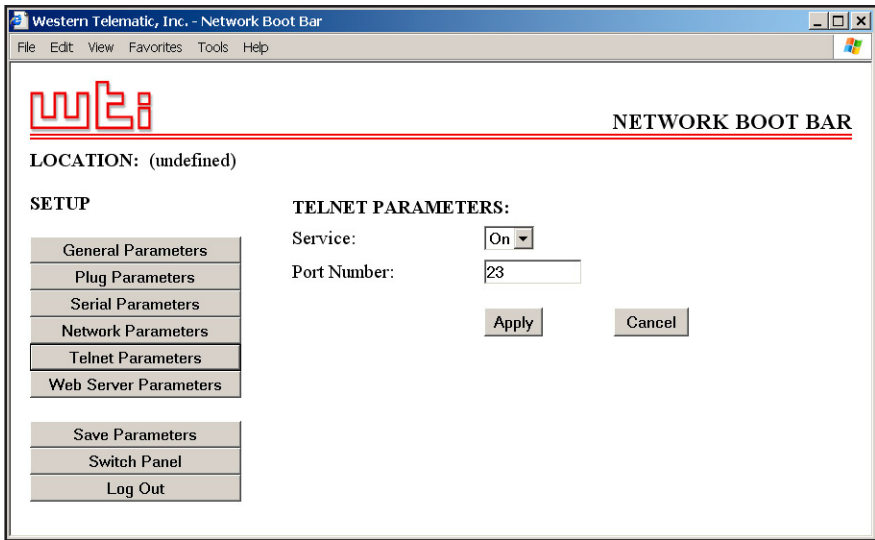

Figure 5.12: Telnet Parameters Menu - Web Browser Interface



Figure 5.13: Telnet Parameters Menu - Text Interface

5.3.5. The Telnet Parameters Menus

The Telnet Parameters Menus are used to enable/disable Telnet access to the NBB command mode and select the TCP port for Telnet connections.

- **Web Browser Interface:** Click the "Setup" button to access the configuration menus, and then click the "Telnet Parameters" button to display the menu shown in Figure 5.12.
- **Text Interface:** Type **/T** and press **[Enter]**. The Telnet Parameters Menu will be displayed as shown in Figure 5.13.

The Telnet Parameters Menus allow the following parameters to be defined. Please note that all parameters listed here are available via both the Web Browser Interface and Text Interface.

- **Service:** Enables/Disables Telnet communication with the NBB unit. When this item is set to the "Off" condition, user's will not be able to contact the unit via Telnet. (Default = On.)
- **Port Number:** Selects the TCP/IP port number that will be used for Telnet connections. (Default = 23.)

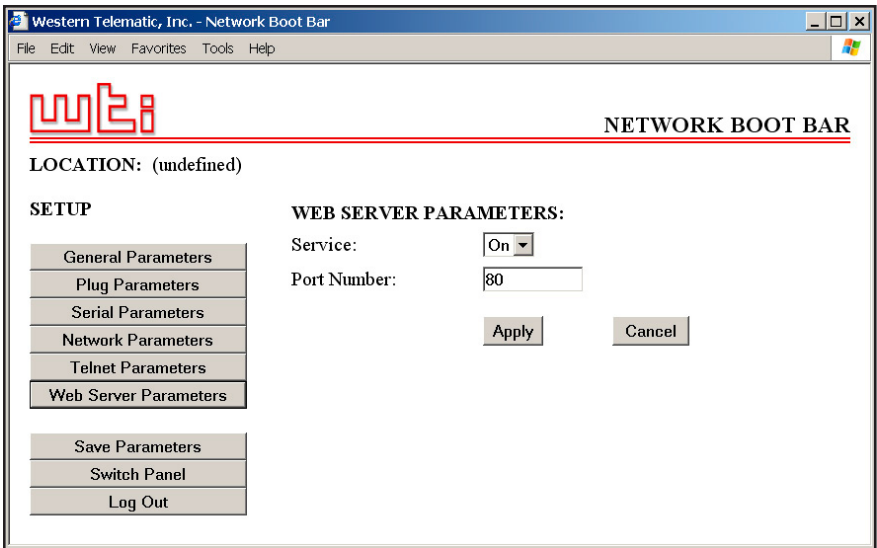

Figure 5.14: Web Browser Parameters Menu - Web Browser Interface



Figure 5.15: Web Browser Parameters Menu - Text Interface

5.3.6. Web Server Parameters Menus

The Web Server Parameters Menus are used to configure the NBB's internal web server, which allows the unit to be operated via the Web Browser Interface.

- **Web Browser Interface:** Click the "Setup" button to access the configuration menus, and then click the Web Server Parameters button. The Web Server Parameters Menu will be displayed as shown in Figure 5.14.
- **Text Interface:** Type **/w** and press **[Enter]**. The Web Server Parameters Menu will be displayed as shown in Figure 5.15.

The Web Server Parameters Menu allows the following parameters to be defined. Please note that all parameters listed here are available via both the Web Browser Interface and Text Interface.

- **Service:** Enables/Disables the NBB's Web Server. Note that when the Web Server is disabled, you will not be able to communicate via the Web Browser Interface. (Default = On.)
- **Port Number:** Sets the TCP/IP Port Number. The Port Number can be set to any valid number except 23; this is because 23 is the default port number that is used for communication with the unit via Telnet. (Default = 80.)

5.4. Save Configuration Parameters

The NBB offers two methods for saving parameters; Saving to Memory, and Saving to an ASCII File.

Saving parameters to memory ensures that your user-defined configuration will remain intact if power to the NBB is temporarily interrupted. After the configuration menus have been used to change parameters, the NBB will prompt you to save parameters before exiting from Command Mode. At this point, the NBB offers the options to Save parameters, continue without saving, or revert to the previously saved parameters.

Saving Parameters to an ASCII file allows you to create a "backup" of your currently defined configuration. As described in Section 7, this provides quick recovery in the event that the unit is accidentally reset to default parameters, and also allows you to copy parameters to other NBB units when several units need to be configured with the same parameters.

Notes:

- After new Parameters have been applied, the NBB will display a "Save" prompt. In the Web Browser Interface, this prompt appears when you leave the configurations menus. In the Text Interface, the "Save" prompt appears when you disconnect from the unit. At this point, you have the option of saving new parameters to memory, continuing without saving, or reverting to previously saved parameters.
- If parameters have not been saved, and if power to the NBB is interrupted, newly defined parameters will be lost. When power is restored, the unit will then be configured with the previously saved parameters.

6. Operation

As discussed in Section 5, "Configuration", the NBB offers two separate command interfaces; the Web Browser Interface and the Text Interface. Note that Both interfaces offer essentially the same command options and features, and that parameters defined via the Web Interface will also apply when communicating via the Text Interface (and vice versa.)

6.1. Operation via the Web Browser Interface

When using the Web Browser Interface, all switching commands are invoked via the Plug Status Screen, which also displays the status of the NBB's switched AC outlets.

6.1.1. The Plug Status Screen - Web Browser Interface

When you log on to the NBB command mode, using the Web Browser Interface, the first screen that is displayed after login is the Plug Status Screen (or "Switch Panel".) The Plug Status Screen (Figure 6.1) lists the current On/Off status of the NBB's Switched Outlets and provides a series of "radio buttons" which are used to control switching and rebooting of the outlets.

To invoke switching and reboot commands or view plug status via the Web Browser Interface, proceed as follows:

1. Access the NBB Command Mode as described in Section 5.2.1.
2. When the Plug Status Screen (Figure 6.1) appears, note that the screen includes a status field and switching and reboot controls for each of the NBB's Switched AC Outlets.

Notes:

- When switching and reboot operations are initiated, Boot/Sequence Delay times will be applied as described in Section 5.3.3.2.
 - Users who log in to command mode with a Plug password, will only be allowed to issue commands to the plugs allowed by that password.
3. **Switching Plugs On:** Click the "On" button next to the desired plug(s), and then click "Apply." To switch all plugs On, click the "On" button in the "All Plugs" row, and then click "Apply."

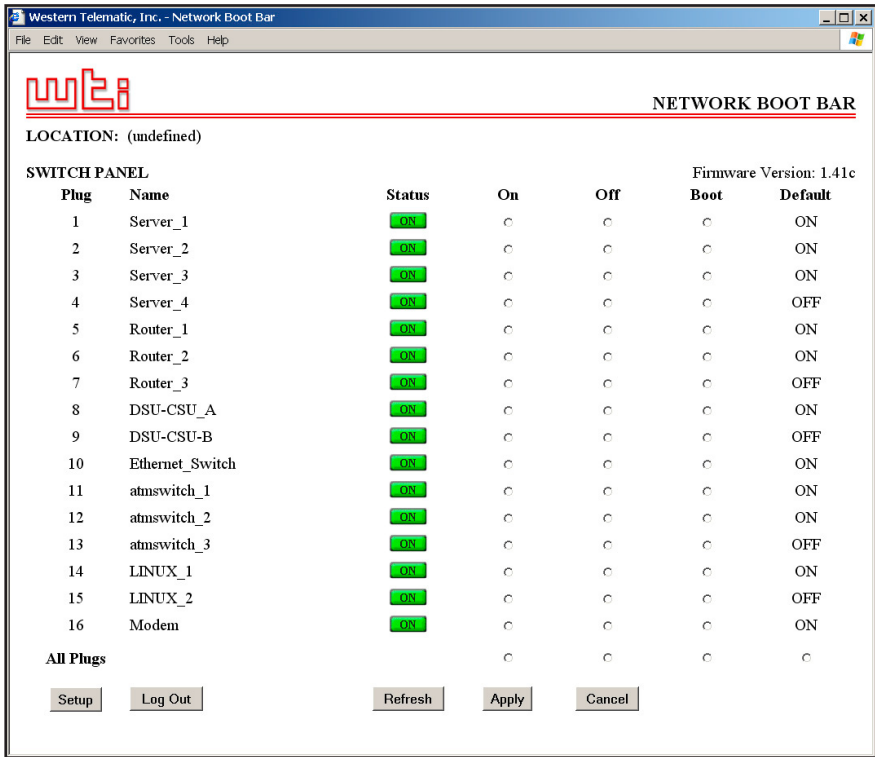

Figure 6.1: Plug Status Menu - Web Browser Interface (Sample Values Shown)

4. **Switching Plugs Off:** Click the "Off" button next to the desired plug(s), and then click "Apply." To switch all plugs Off, click the "Off" button in the "All Plugs" row, and then click "Apply."
5. **Reboot Cycle:** Click on the "Boot" button next to the desired plug(s), and then click "Apply." To reboot all plugs, click the "Boot" button in the "All Plugs" row and then click "Apply."
6. **Set Plugs to Power Up Defaults:** To set all plugs to their user-defined Power Up Default On/Off status, click the "Default" button in the "All Plugs" row and then click "Apply." Note that in order for this command to function, Power Up Default values for each plug must first be defined as described in Section 5.3.3.

When each switching, reboot or default command is invoked, the NBB will display a screen which indicates that a switching operation is in progress, then return to the Plug Status Screen when the command is complete. At that time, the Status Screen will list the updated On/Off status of each plug.

```

Network Boot Bar v1.41c           Site ID: (undefined)

Plug | Name                | Password | Status | Boot/Seq. Delay | Default |
-----+-----+-----+-----+-----+-----+
 1 | Server_1             | (defined) | ON    | 15 Secs         | ON     |
 2 | Server_2             | (defined) | ON    | 15 Secs         | ON     |
 3 | Server_3             | (defined) | ON    | 15 Secs         | ON     |
 4 | Server_4             | (defined) | ON    | 15 Secs         | OFF    |
 5 | Router_1             | (defined) | ON    | 0.5 Secs        | ON     |
 6 | Router_2             | (defined) | ON    | 0.5 Secs        | ON     |
 7 | Router_3             | (defined) | ON    | 0.5 Secs        | OFF    |
 8 | DSU-CSU_A            | (defined) | ON    | 1 Sec           | ON     |
 9 | DSU-CSU-B            | (defined) | ON    | 1 Sec           | OFF    |
10 | Ethernet_Switch      | (defined) | ON    | 0.5 Secs        | ON     |
11 | atmswitch_1          | (defined) | ON    | 2 Secs          | ON     |
12 | atmswitch_2          | (defined) | ON    | 2 Secs          | ON     |
13 | atmswitch_3          | (defined) | ON    | 2 Secs          | OFF    |
14 | LINUX_1              | (defined) | ON    | 5 Secs          | ON     |
15 | LINUX_2              | (defined) | ON    | 5 Secs          | OFF    |
16 | Modem                | (defined) | ON    | 30 Secs         | ON     |
-----+-----+-----+-----+-----+
"/H" for help.
NBB>

```

Figure 6.2: Plug Status Screen - Text Interface

6.2. Operation via the Text Interface

When using the Text Interface, all switching functions are performed by invoking simple, ASCII commands. ASCII commands are also used to display status screens and to log out of command mode. The Text Interface also includes a Help Menu, which summarizes all available NBB commands. To display the Text Interface Help Menu (Figure 6.3), type **/H** and press **[Enter]**.

6.2.1. The Plug Status Screen - Text Interface

When you log in to the NBB command mode using the Text Interface, the first screen displayed after login is the Plug Status Screen. The Plug Status Screen (Figure 6.2) lists the current status of the NBB's Switched AC Outlets and displays the firmware version and currently defined Site I.D. Message.

Normally, the Plug Status Screen will also be redisplayed each time a command is successfully executed. Note however, that if desired, the Automated Mode (See Section 6.4) can be enabled to suppress the display of the Plug Status Screen after each command.

```

Network Boot Bar v1.41c          Site ID: (undefined)

Display                          Configuration
/H      Display Help Screen      /G      View/Set General Parameters
/S      Display Plug Status      /P [n]  View/Set Plug Parameters
/SN     Display Network Status   /C      View/Set Serial Parameters
Control                               /N      View/Set Network Parameters
/D      Set Plugs to Default     /T      View/set Telnet Parameters
/Boot <n> Boot Plug n            /W      View/Set Web Server
/On <n>  Turn On Plug n         /E      Save Parameters
/Off <n> Turn Off Plug n        /R      Recall Parameters
/X      Exit/Disconnect         /DL     Download Parameters to File

                                           Utilities
+-----+-----+
| [n] = optional plug name or number | /I      Reset Network Interface
| <n> = required plug name or number | /U      Upgrade Firmware
| n+n or n n = plug n and plug n   |
| n:n = plug n through plug n     |
| * = all plugs                    |
| ,y = bypass "Sure? (y/n)"       |
+-----+-----+

NBB>

```

Figure 6.3: The NBB Help Screen - Text Interface

6.2.2. Switching and Reboot Commands - Text Interface

These commands can be used to switch plugs On/Off, reboot plugs or set plugs to their user-defined Power Up Default values. Plugs may be specified by name or number.

Notes:

- Wait for the command prompt to appear before entering additional commands. The prompt will not reappear until the previous command is complete.
- Commands are *not* case sensitive. All commands are invoked by pressing **[Enter]**.
- Users who log into command mode with a Plug password, will only be allowed to issue commands to the plugs allowed by that password.
- If command confirmation is enabled, the NBB will display the Status Screen after commands are successfully completed.
- When switching or reboot operations are initiated, Boot/Sequence Delay times will be applied as described in Section 5.3.3.2.

To switch plugs On/Off, initiate a reboot cycle, or set plugs to their Power Up Default values, proceed as follows:

1. **Switch Plug(s) On:** Type `/ON n` and press **[Enter]**. Where "*n*" is the number or name of the desired plug. For example:

`/ON 1` or `/ON ROUTER`

2. **Switch Plug(s) Off:** Type `/OFF n` and press **[Enter]**. Where "*n*" is the number or name of the desired plug. Note that the `/OFF` command can also be entered as `/OF`. For example:

`/OFF 2` or `/OF ROUTER`

3. **Boot Plug(s):** To initiate a reboot cycle, type `/BOOT n` and press **[Enter]**. Where "*n*" is the number or name of the desired plug. Note that the `/BOOT` command can also be entered as `/BO`. For example:

`/BOOT 1` or `/BO ATMSWTCH`

4. **Set Plugs to Power Up Defaults:** Type `/D` and press **[Enter]**. Plugs will be set to their default On/Off status (Power Up Default), which is defined using the Plug Parameters Menu as described in Section 5.3.3.

Notes:

- When you have accessed command mode using the System Password, the Default command will be applied to all plugs.
 - When you have accessed command mode using a Plug (User) Password, the Default command will only be applied to the plugs permitted by the password.
5. **Suppress Command Confirmation Prompt:** To execute a switching or reboot command without displaying the "Sure?" prompt, include the `,Y` option at the end of the command line. For example:

`/ON ROUTER,Y` or `/BOOT 2,Y`

6.2.3. Applying Commands to Several Plugs - Text Interface

As described below, switching and reboot commands can be applied to only one Switched AC Outlet, or to an assortment of outlets.

Notes:

- When switching or reboot operations are initiated, Boot/Sequence Delay times will be applied as described in Section 5.3.3.2.
 - Switching and reboot commands will only be applied to the outlets that are allowed by the password that was used to access command mode.
1. **Several Plugs:** To apply a switching or reboot command to several plugs, enter the numbers or names for the plugs, separated by a "plus sign" (+). For example to switch plugs 1, 4, and 5 Off, enter the following:

/OFF 1+4+5 [Enter]

2. **Series of Plugs:** To apply a command to a series of NBB Plugs, enter the number for the plugs that mark the beginning and end of the series, separated by a colon. For example, to switch plugs 1 through 3 On, enter the following:

/ON 1 : 3 [Enter]

3. **All Plugs:** To apply a command to all plugs, enter an asterisk in place of the name or number. For example, to Boot all plugs, enter the following:

/BO * [Enter]

6.3. Logging Out of Command Mode

When you have finished communicating with the NBB, it is important to always disconnect using either the "Log Out" button (Web Browser Interface) or /X command (Text Interface), rather than simply closing your browser window or communications program.

When you disconnect using the Log Out button or /X command, this ensures that the NBB has completely exited from command mode, and is not waiting for the inactivity timeout period to elapse before allowing additional connections. This ensures that NBB unit will be available to other users, and they will not have to wait for the timeout period to elapse before accessing the NBB Command Mode.

6.4. The Automated Mode

The Automated Mode allows the NBB to execute switching and reboot commands, without displaying menus or generating response messages. Automated Mode is designed to allow the NBB to be controlled by a device which can generate commands to control power switching functions without human intervention.

When the Automated Mode is enabled, the /ON, /OFF, /BOOT, /D and /X commands are executed without a "Sure?" confirmation prompt and without command response messages; the only reply to these commands is the "NBB>" prompt, which is displayed when the command is complete.

Note that although the Automated Mode can be enabled using either the Web Browser Interface or Text Interface, Automated Mode is designed primarily for users who wish to send ASCII commands to the NBB without operator intervention, and therefore does not specifically apply to a GUI style, Web Browser Interface. When the Automated Mode is enabled, the Web Browser Interface can still be used to invoke On / Off / Boot commands.

Notes:

- When Automated Mode is enabled, all NBB password security functions are disabled, and users are able to access System Level command functions (including the configuration menus) and control plugs without entering a password.
- If you need to enable the Automated Mode, but want to restrict network access to NBB configuration menus, it is recommended to enable and configure the IP Security Function as described in Section 5.3.4.1.

To enable the Automated Mode, access the General Parameters menu (see Section 5.3.1) and then set the "Automated Mode" option to the "On" state. When the Automated Mode is enabled, NBB functions will change as follows:

1. **All Password Security Suppressed:** When a user attempts to access the command mode, the password prompt will not be displayed at either the Console Port or Network Port. Unless specifically restricted by the IP Security Function, all users will be allowed to access both switching and configuration functions, and all commands will be immediately accepted without the requirement to enter a password.
2. **Status Screen Suppressed:** The status screens will not be automatically displayed after commands are successfully executed. Note however, that the /S command can still be invoked to display the status screen if needed.
3. **"Sure?" Prompt Suppressed:** All commands are executed without prompting for user confirmation.
4. **Error Messages Suppressed:** If the [Enter] key is pressed without entering a command, the NBB will not respond with the "Invalid Command" message. Note however, that an error message will still be generated if commands are invoked using invalid formats or arguments.

All other status display and configuration commands will still function as normal.

6.5. Manual Operation

In addition to the command driven functions available via the Web Browser Interface and Text Interface, the NBB's switched plugs can also be toggled On and Off manually. To manually toggle plugs On or Off, press the Manual Control Button, and hold it down for approximately three seconds.

If desired, the Manual Switch Button Option (accessed via the General Parameters Menu), can be used to completely disable the manual power button as described in Section 5.3.1.

For more information on the Manual Switch Button Parameter, please refer to Section 5.3.1.

Note: When the Manual Switch Button is used, Boot / Sequence Delay Times will be applied.

7. Saving and Restoring Configuration Parameters

After the NBB has been properly configured, parameters can be downloaded and saved as an ASCII text file on your local or remote PC. Later, if the configuration is accidentally altered, the file with the saved parameters can be uploaded to automatically reconfigure the unit without the need to manually assign each parameter.

Saved parameters can also be uploaded to other NBB units. This allows rapid set-up when several units will be configured with the same parameters.

The "Save Parameters" procedure can be performed from any terminal emulation program (e.g. ProComm, Crosstalk, Hyperterminal, etc.), which allows downloading of ASCII files.

Note: Although this function is available only via the Text Interface, parameters that have been defined via the Web Browser Interface will also be sent to the ASCII file.

7.1. Sending Parameters to a File

1. Start your communications program and access the NBB command mode using the System Level Password.
2. When the NBB command prompt appears, type **/DL** and press **[Enter]**. The NBB will prompt you to prepare your communications program. Set up your communications program to receive an ASCII download, and specify a name for the file that will receive the saved parameters (e.g., NBB.PAR).
3. When the communications program is ready to receive the file, return to the NBB command mode, and press **[Enter]** to proceed.
4. The NBB will send a series of ASCII command lines which specify the currently selected NBB parameters.

7.2. Restoring Saved Parameters

This section describes the procedure for using ProComm to send saved parameters to the NBB.

Note: Parameters that have been saved to an ASCII file can only be restored via the Text Interface. This procedure cannot be performed via the Web Browser Interface.

1. Start your communications program and access the NBB command mode via the Text Interface as described in Section 5.2.2.
2. If the Password Prompt is displayed, key in your System Level Password and press **[Enter]**.
3. Configure your communications program to upload an ASCII text file.
4. Upload the file with the saved parameters. If necessary, key in the file name and directory path.
5. When the upload is complete, make certain to terminate the communications program's upload mode.

Note:

- The current On/Off status of each NBB plug will not be saved or restored. However, the selected default On/Off setting for each plug will be saved and restored.
- When the configuration file is sent to the NBB via telnet, the unit's IP Address, Subnet Mask, and Gateway Address will not be changed until after you exit from command mode.

At this point, saved parameters should have been restored to the NBB unit. Check the Plug Status Screen, General Parameters Menu, Plug Parameters Menu and Network Parameters Menu to make certain that saved parameters have been accurately restored.

8. Upgrading the NBB Firmware

When new, improved versions of the NBB firmware become available, the "Upgrade Firmware" function can be used to update the unit. Updates can be installed via the Console Port or Network Port.

Notes:

- The upgrade procedure can only be performed via the Text Interface.
 - All other network ports will be disabled during the firmware upgrade procedure.
 - When the upgrade procedure is complete, all parameters will be set to their default states. Therefore, it is recommended to save NBB configuration parameters to an ASCII file (as described in Section 7) before beginning this upgrade procedure.
1. Obtain the update file. Firmware modifications can either be mailed to the customer on a CDR, or downloaded from WTI. Place the upgrade CDR in your disk drive or copy the file to your hard drive.
 2. Access the NBB command mode via the Text Interface. When the password prompt is displayed, key in the System Level Password.
 3. When the command prompt appears, type **/U** and press **[Enter]**. The NBB will display a screen which offers the following options:
 - 1. Upgrade Sector 0
 - 2. Upgrade Sectors 1 - 4
 - 3. Upgrade Sectors 5 - 7
 - 4. Abort Upgrade

Note: Instructions regarding the proper Sector option will be supplied when upgrades become available.

Select the Sector Option indicated for the upgrade and press **[Enter]**, or type **4 [Enter]** to abort the upgrade procedure.

4. Set your communication program for ASCII Mode, then use the program's "Send File" function to transfer the upgrade file to the NBB. Select ASCII format, then specify the filename and directory location where the firmware upgrade file resides.
5. If the upload is successful, the NBB will load the upgrade firmware into memory, and then reboot itself.

Note: If you are performing the upgrade procedure via the Network Port, the NBB will break the network connection when the system is reinitialized. However, the NBB will retain the current settings for the IP Address, the Telnet Port Number, Web Server Port Number and Console Port Mode and Baud Rate.

6. **Incomplete Upload:** If the upload is interrupted, times-out, or if the update file becomes corrupted during transfer, the NBB will display a screen which asks for confirmation before proceeding. To proceed, type **1** and press **[Enter]**, then return to Step 4 above to retry the upload, or press **[Esc]** to reboot the NBB unit.
7. **Recovery Mode:** In the rare event that the NBB operating system becomes corrupted during installation, front panel indicators will blink, and the unit will automatically switch to Recovery Mode. If the unit switches to Recovery Mode, first access the NBB command mode to reset the Console Port to 9600 bps, Eight Data Bits, No Parity, One Stop Bit, and then return to step 3 above and repeat the upload procedure.

When firmware upgrades are available, WTI will provide the necessary files via download or mailed CDROM. At that time, an updated Users Guide or addendum will also be available.

A. Interface Descriptions

A.1. Console Port Interface

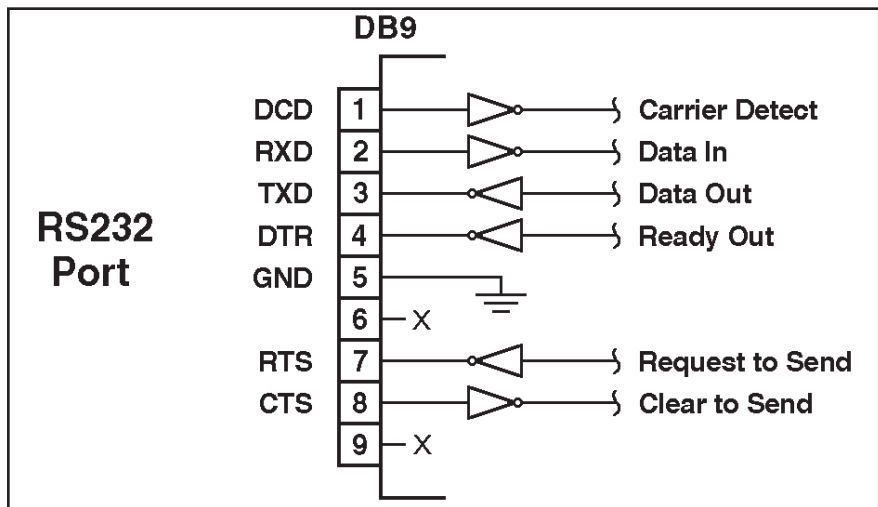

Figure A.1: Console Port Interface

B. Specifications

Power Input / Output ; Model NBB-1600-D20 (120 VAC)

AC Input: Two Separate Circuits; 20 Amps Max. per Circuit (40 Amps Total)

- **Voltage:** 100 - 120 VAC 60 Hz
- **Connectors:** Two (2) IEC320-C20 Inlets

AC Outputs: Sixteen (16) Plugs, Split into Two 20 Amp Circuits.

- **Connectors:** Sixteen (16) NEMA 5-15R Outlets
- **Load:**

Each Outlet: 15 Amps

Circuit "A" (Plugs 1 to 8): 20 Amps Total

Circuit "B" (Plugs 9 to 16): 20 Amps Total

Power Input / Output ; Model NBB-1600E-D20 (208 VAC)

AC Input: Two Separate Circuits; 20 Amps Max. per Circuit (40 Amps Total)

- **Voltage:** 100 - 240 VAC 50/60 Hz
- **Connectors:** Two (2) IEC320-C20 Inlets

AC Outputs: Sixteen (16) Plugs, Split into Two 20 Amp Circuits.

- **Connectors:** Sixteen (16) IEC320-C13
- **Load:**

Each Outlet: 15 Amps

Circuit "A" (Plugs 1 to 8): 20 Amps Total

Circuit "B" (Plugs 9 to 16): 20 Amps Total

Power Input / Output ; Model NBB-1600CE-D16 (230 VAC)

AC Input: Two Separate Circuits; 16 Amps Max. per Circuit (32 Amps Total)

- **Voltage:** 100 - 240 VAC 50/60 Hz
- **Connectors:** Two (2) IEC320-C20 Inlets

AC Outputs: Sixteen (16) Plugs, Split into Two 16 Amp Circuits.

- **Connectors:** Sixteen (16) IEC320-C13
- **Load:**

Each Outlet: 10 Amps

Circuit "A" (Plugs 1 to 8): 16 Amps Total

Circuit "B" (Plugs 9 to 16): 16 Amps Total

Console / Modem Port Interface:

Connector: DB9M, RS232C, DTE

Coding: Serial ASCII, 8 Bits, No Parity

Physical / Environmental:

Size:

- **Length:** 43.75" (111.1 cm)
- **Depth:** 3.00" (7.6 cm)
- **Width:** 1.75" (4.5 cm)

Weight: 12 lbs. Shipping Weight

Temperature: (Operating) 32°F to 122°F (0°C to 50°C)

Humidity: 10 - 90% RH

C. Customer Service

Customer Service hours are from 8:00 AM to 5:00 PM, PST/PDT, Monday through Friday. When calling, please be prepared to give the name and model of the unit, its serial number and a description of its symptoms. If the unit should need to be returned for factory repair it must be accompanied by a Return Authorization number from Customer Service.

WTI Customer Service
5 Sterling
Irvine, California 92618
Toll Free Service Line: 1-888-280-7227
Local Phone: (949) 586-9950
Service Fax: (949) 457-8138
Email: service@wti.com

Trademark and Copyright Information

WTI and Western Telematic are trademarks of Western Telematic Incorporated. All other product names mentioned in this publication are trademarks of their respective companies.

Information and descriptions contained herein are the property of Western Telematic, Inc.. Such information and descriptions may not be copied, disseminated or distributed without the express written consent of Western Telematic, Incorporated.

©Copyright Western Telematic, Inc. 2005. All rights reserved. Printed in the United States of America.

February 2006

WTI Part Number: 13631, Rev. A

Index

A		F	
Activity Indicator	2-2	Firmware Setup	5-1 to 5-18
Automated Mode	5-9, 6-7	Firmware Upgrade	8-1 to 8-2
B		Front Panel	2-1 to 2-2
Baud Rate		G	
Console Port	5-11	Gateway Address	5-16
Boot/Sequence Delay	5-15	General Parameters Menu	5-6 to 5-9
Boot/Sequence Delay Time	6-8	Grounding	i
Booting Plugs	6-5	H	
Boot Command	6-6	Hardware Description	2-1 to 2-2
Button Mode	5-9	Hardware Installation	4-1 to 4-2
C		Help Screen	6-3
Cable Keeper	2-2	I	
Cable Keepers	4-1	Inactivity Timeout	5-9
Co-location	5-14	Indicators	2-1 to 2-2
Command Confirmation	5-9, 6-5, 6-8	Installation	4-1 to 4-2
Command Echo	5-8	Interface Description	Apx-1
Command Mode Access	5-2 to 5-4	IP Address	5-16
Local PC	5-4	Default	4-3, 5-3, 5-16
Modem	5-4	IP Security	5-18 to 5-19
Network	5-4	J	
Text Interface	5-4 to 5-5	JavaScript	5-3
Web Browser Interface	5-3 to 5-4	L	
Command Prompt	5-9	LED Indicators	2-1 to 2-2
Configuration	5-1 to 5-18	Local PC	4-2, 5-4
Menus	5-6 to 5-19	Logging Out	6-7
Confirmation Prompt	5-9	M	
Console Port	2-2, 4-2, 5-11, Apx-1	MAC Address	5-16
Baud Rate	5-11	Manual Operation	6-8
Data Bits	5-11	Manual Switch Button	2-2, 5-9, 6-8
Parity	5-11	Master Power Switch	2-2
Stop Bits	5-11	Maximum Segment Size	5-16
Customer Service	Apx-3	Modem	5-4, 5-11
D		Connection	4-2
Data Bits	5-11	Modem Init String	5-11
Default On/Off	5-13	N	
Default Parameters	5-9	Network Access	5-4, 5-5
Delay Period	5-15	Network Parameters Menus	5-16 to 5-19
Deny Access	5-18	Network Port	2-2, 4-3, 5-16 to 5-19
Disable Telnet	5-20 to 5-21	Network Status Screen	5-16
Downloading Parameters	7-1	O	
Duplex Mode	5-8	Off Command	6-5 to 6-6
E		On Command	6-5 to 6-6
Error Messages	6-8	Operation	6-1 to 6-8
Ethernet Port	2-2, 4-3	Manual	6-8
External Modem	4-2, 5-11	Text Interface	6-3 to 6-5
		Web Browser Interface	6-1 to 6-3

P		S	
Parameters	5-1 to 5-18	Saving Parameters	5-22, 7-1
Restoring	7-2	Sectors	8-1
Saving	5-22, 7-1	Security	5-1, 5-18 to 5-19
Parity	5-11	Segment Size	5-16
Password	5-1, 5-3, 5-5, 6-8	Send MSS	5-16
Plug	5-13	Sequence Delay	5-13 to 5-14, 5-15
System	5-8	Serial Parameters Menu	5-10 to 5-11
User	5-13	Serial Port	2-2, 4-2
Permit Access	5-18	Serial Port Mode	5-11
Plugs	2-2	Service	Apx-3
Plug Control	6-6	Telnet	5-20
Plug Control Button	5-9	Web Server	5-22
Plug Name	5-13	Site I.D. Message	5-8
Plug Parameters Menu	5-12 to 5-14	Specifications	Apx-2
Plug Password	5-13	Stop Bits	5-11
Plug Status Screen	6-8	Subnet Mask	5-16
Text Interface	6-3	Sure Prompt	5-9, 6-5, 6-8
Web Browser Interface	6-1	Switched Outlets	2-2
Port Number		Switched Plugs	4-2
Telnet	5-20	Switching Plugs	6-1 to 6-8, 6-5
Web Server	5-22	System Mode	5-1, 5-14
Power Control		System Password	5-8
Manual	6-8		
Text Interface	6-3 to 6-5	T	
Web Browser Interface	6-1 to 6-3	Technical Support	Apx-3
Power Inlet	2-2	Telnet	
Power Supply	i, 4-1	Disable	5-20 to 5-21
Power Up Default	5-13, 6-2	Port Number	5-20
		Service	5-20
		Telnet Parameters Menu	5-20
Q		Text Interface	5-4 to 5-5, 6-3 to 6-5
Quick Start Procedure	3-1 to 3-4	Timeout	5-9
		U	
R		Unit Description	2-1 to 2-2
Rack Mounting	i	Upgrade Firmware	8-1 to 8-2
Ready Indicator	2-2	Uploading Parameters	7-2
Rebooting Plugs	6-1 to 6-8	User Mode	5-1, 5-14
Reboot Cycle	6-2, 6-5	User Name	5-3, 5-8
Reset Parameters	5-9	User Password	5-13
Restoring Parameters	7-2		
		W	
		Warnings and Cautions	i
		Web Browser Interface	5-3 to 5-4, 6-1 to 6-3
		Web Server	
		Port Number	5-22
		Service	5-22
		Web Server Parameters Menu	5-21 to 5-22
		Wild Card	5-18



**5 Sterling • Irvine • California 92618
(949) 586-9950 • Toll Free: 1-800-854-7226
Fax: (949) 583-9514 • <http://www.wti.com>**