

# SNK Series



## Model: SNK217C32

SUN Solaris Compatible Keyboard 2U  
 Rackmount 17" LCD Keyboard Drawer with 32-port  
 CAT5 KVM Switches Keyboard Drawer and USB KVM



### LCD Drawer & KVM Benefits:

- High density Cat5 KVM with either 16 or 32 ports in 2U
- Cost efficient DB-15KVM integration
- Single or "One Man" installation slide for easy, quick installation
- 104 key notepad keyboard with full numerical pad
- Mix PS/2, USB & SUN Multi-Platform switch capability
- Secure remote User access across the world wide web

### LCD Features:

- 2U rackmount drawer with either 17" or 19" SAMSUNG LCD
- Either PS/2 or USB input to the LCD Drawer by cable selection
- Multiple keyboard language selections with either touchpad or trackball
- slide rails with fixed positions to prevent drawer movement when typing
- Multi lingual on screen display menu
- 12, 24 and 48 volt DC power options

### KVM Features and Benefits:

- Use of the RJ45 Cat5 interface allows for a higher number of ports in smaller density
- Greater distances between your switch and servers allow enhanced data centre rack layouts
- Traditional Cat5 cords, when compared to coaxial cables, provide simple cable management
- Mix legacy PS/2 servers with newer USB and SUN solutions
- Multi lingual on screen display menu
- Advanced user profiles and configurable OSD hot key combinations
- 12, 24 and 48 volt DC power options

### Mechanical Drawing:

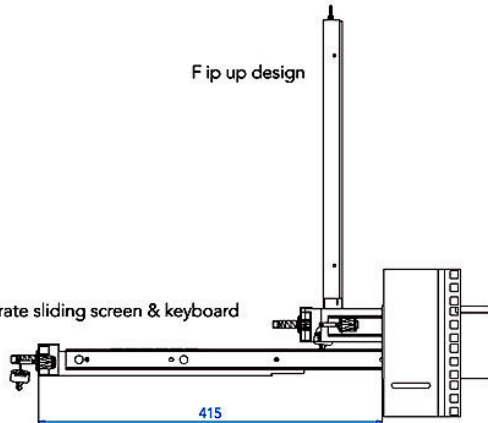
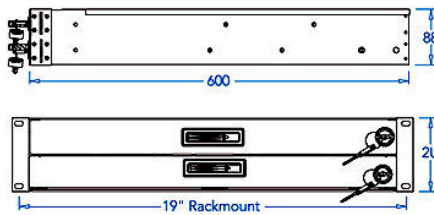

Unit : mm



User profile with access right

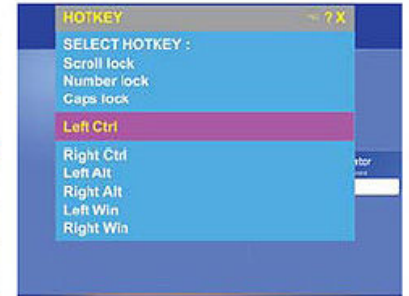

Various OSD hotkey combinations

### High Density Cat 5 KVM

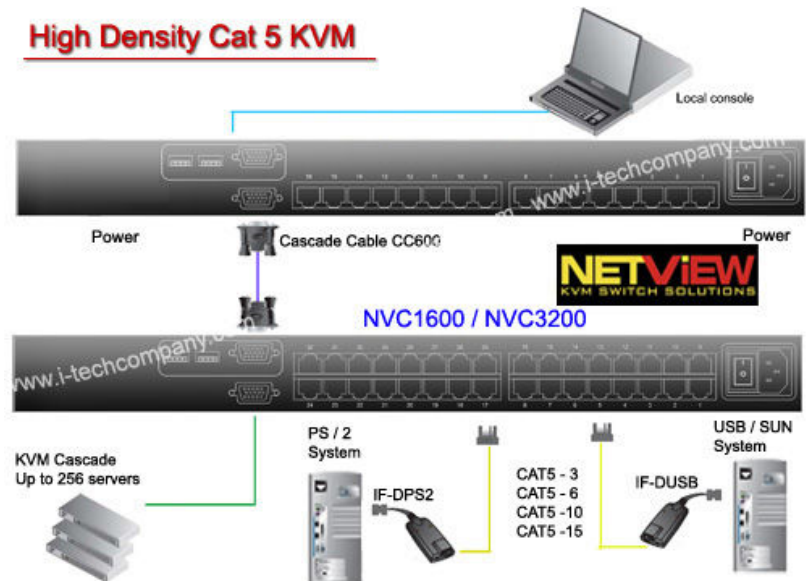

**e** keyboard integrated with touchpad

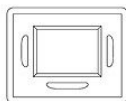
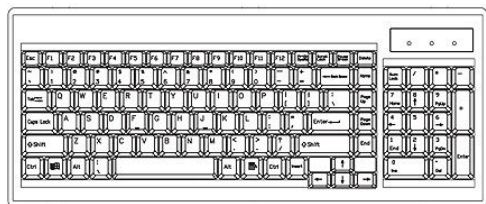

**b** keyboard integrated with trackball

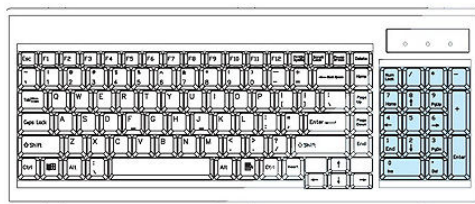

**Specifications:**

LCD	
Panel	Samsung 17" LCD Panel
Screen Type	TFT
Display Area	337.92(H) x 270.34(V) mm
Contrast Ratio	500 : 1
Viewing Angle	140 ° (H) x 120 ° (V) (Typ.)
Resolution	1280 x 1024
Pixel pitch	<b>0.264(H) x 0.264(W) mm</b>
Response Time	T <sub>r</sub> =5ms, T <sub>f</sub> =20ms (Typ.)
Brightness	300 cd/m <sup>2</sup>
Panel Color	16.2M
Back Light	4 CCFTs (Cold Cathode Fluorescent tube)
Video	
Horizontal Synchronization	64 - 80 KHz (Typ.)
Vertical Synchronization	60 - 75 Hz (Typ.)
Input Signal	Analog RGB 0.7Vp-p
Power Management	
VESA DPMS	
Control	
OSD Control	Brightness, Contrast, Colour, Clock, H.Position, V.Position, Phase, Scaling, Auto config, Input select, Multi window, Clear EEPROM, OSD adjust, Save
External Connection	
Power Input	12V/5A DC adapter
Video Input	15-pin D-Sub connector

**KVM Technical Specifications:**

KVM Port	
Number of ports :	16or32
Connector:	RJ-45
Connectivity:	USB type or PS/2 type dongle, up to 40 meter ( 130 feet)
Local Console	
Graphic connector:	HDDB15-pin HDDB15-pin, VGA
Resolution:	Up to 1600x1200
Input device:	2 x USB type A for keyboard & mouse
Management	
Multilingual OSD :	English, France, German, Spanish, Italian, Russian, Simplified Chinese,Japanese
Hotkey combination :	Scroll-lock, Cap-lock, Num-lock, Alt, Ctrl & WinSecurity:
Security:	Password enable & disable, up to 8 users profile for port access
PC Selection:	Front button, OSD menu & hotkey
Expansion :	
	Up to 256 servers by 8-level cascade
Compatibility	
Multi-platform	Mix PCs, SUNs, IBMs, HPs, DELLs Server
:Support:	Windows Vista, 2003 / XP / 2000, Linux, Netware, Unix
Power	
Input:	100-240VAC, 50 or 60Hz, IEC type cord
Option DC :	12V/24V/48V DC input
Consumption :	Max. 25 Watt
Regulatory Approval	
	FCC,CE
Environmental	
Operating :	0 to 50°C
Storage:	-10 to 60-C
Relative humidity:	90%, non-condensing
Shock:	50G peak acceleration (11 ms, half-sine wave)
Vibration :	58~100Hz / 0.98G (11 min / cycle)