



Model: SNX117CCE32e / SNX117CCE32b
1U SUN Solaris Compatible Rackmount 17" LCD Monitor
Keyboard 32-port CAT5 KVM Switch, 2 consoles (Local
+ Remote Via CAT 5 Extenders)

LCD Drawer & KVM Benefits:

- High density Cat5 KVM with either 16 or 32 ports in 1U
- Cost efficient DB-15KVM integration
- Single or "One Man" installation slide for easy, quick installation
- 104 key notepad keyboard with full numerical pad and AUN function
- Mix USB & SUN with Multi-Platform switch capability
- Secure remote user access across the world wide web

LCD Features:

- 1U rackmount drawer with either 17" or 19" SAMSUNG LCD
- Either PS/2 or USB input to the LCD Drawer by cable selection
- Multiple keyboard language selections with either touchpad or trackball
- slide rails with fixed positions to prevent drawer movement when typing
- Multi lingual on screen display menu
- 12, 24 and 48 volt DC power options

Mechanical Drawing:

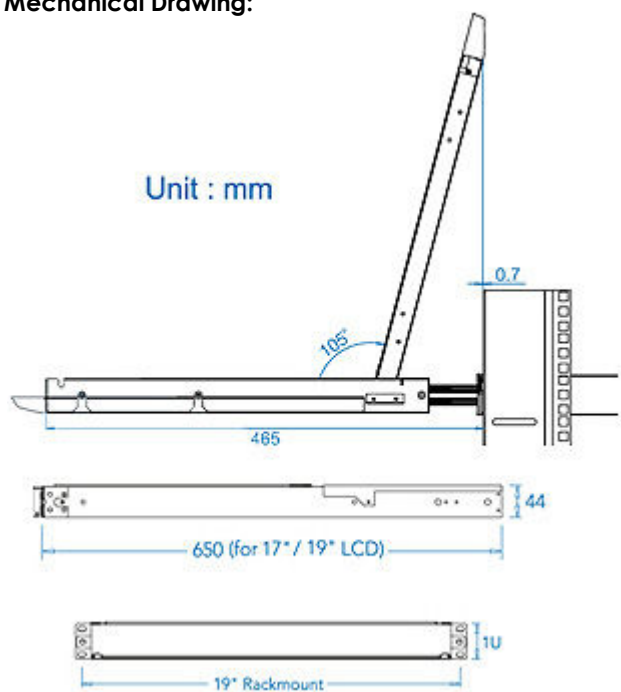

KVM Features and Benefits:

- Use of the RJ45 Cat5 interface allows for a higher number of ports in smaller density
- Greater distances between your switch and servers allow enhanced data centre rack layouts
- Traditional Cat5 cords, when compared to coaxial cables, provide simple cable management
- Mix legacy PS/2 servers with newer USB and SUN solutions
- Multi lingual on screen display menu
- Advanced user profiles and configurable OSD hot key combinations
- 12, 24 and 48 volt DC power options

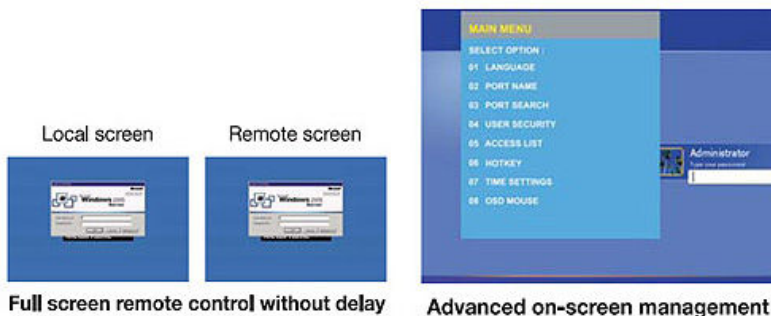

High Density Cat 5 KVM

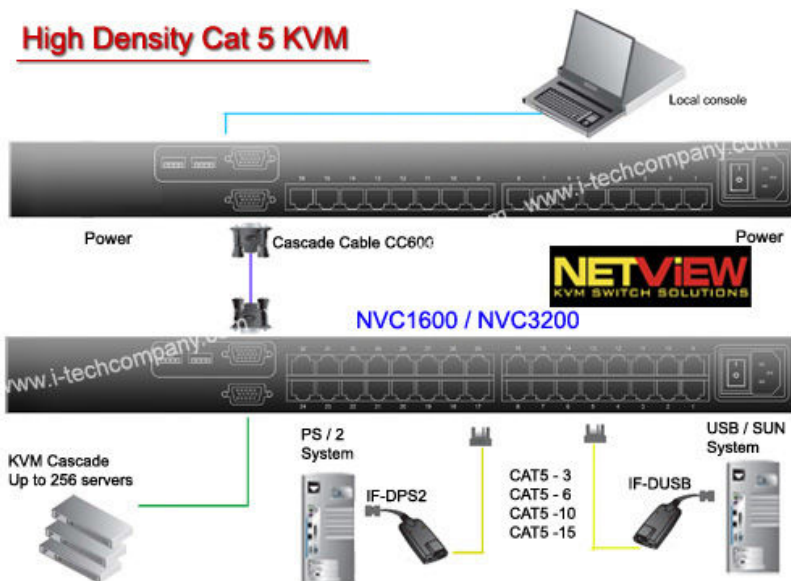

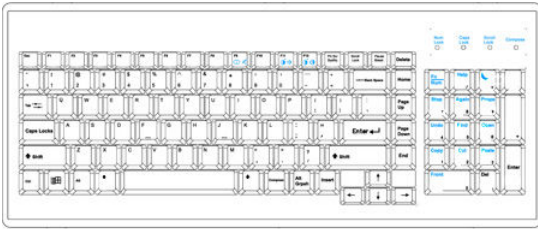

(e) SUN Keyboard

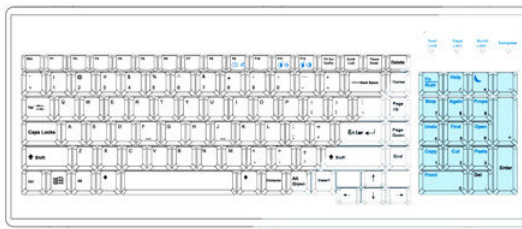

(b) SUN Keyboard

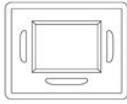

Specifications:

LCD	
Panel	Samsung 17" LCD Panel
Screen Type	TFT
Display Area	337.92(H) x 270.34(V) mm
Contrast Ratio	500 : 1
Viewing Angle	140 ° (H) x 120 ° (V) (Typ.)
Resolution	1280 x 1024
Pixel pitch	0.264(H) x 0.264(W) mm
Response Time	Tr=5ms, Tf=20ms (Typ.)
Brightness	300 cd/m2
Panel Color	16.2M
Back Light	4 CCFTs (Cold Cathode Fluorescent tube)
Video	
Horizontal Synchronization	64 - 80 KHz (Typ.)
Vertical Synchronization	60 - 75 Hz (Typ.)
Input Signal	Analog RGB 0.7Vp-p
Power Management	
VESA DPMS	
Control	
OSD Control	Brightness, Contrast, Colour, Clock, H.Position, V.Position, Phase, Scaling, Auto config, Input select, Multi window, Clear EEPROM, OSD adjust, Save
External Connection	
Power Input	12V/5A DC adapter
Video Input	15-pin D-Sub connector

KVM Technical Specifications:

KVM Port	
Number of ports :	16or32
Connector:	RJ-45
Connectivity:	USB type or PS/2 type dongle, up to 40 meter (130 feet)
Local Console	
Graphic connector:	HDDB15-pin HDDB15-pin, VGA
Resolution:	Up to 1600x1200
Input device:	2 x USB type A for keyboard & mouse
Remote Console	
Connector:	HDDB15-pin, VGA
Resolution:	Up to 1600 x 1200 (500feet), Up to 1024 x768 (1000feet)
Input device:	2 x USB type Afor Keyboard &mouse
Remote I/O:	RJ45 vio Cat5/ Cat5e/cat6/ cable up to 1000feet
Compensation	Auto adjust for cable length
Expansion :	
	Up to 256 servers by 8-level cascade
Compatibility	
Multi-platform	Mix PCs, SUNs, IBMs, HPs, DELLs Server
:Support:	Windows Vista, 2003 / XP / 2000, Linux, Netware, Unix
Power	
Input:	100-240VAC, 50 or 60Hz, IEC type cord
Option DC :	12V/24V/48V DC input
Consumption :	Max. 25 Watt
Regulatory Approval	FCC,CE
Environmental	
Operating :	0 to 50°C
Storage:	-10 to 60-C
Relative humidity:	90%, non-condensing
Shock:	50G peak acceleration (11 ms, half-sine wave)
Vibration :	58~100Hz / 0.98G (11 min / cycle)