

iDP-2000A Mounting Method

100mm VESA standard

UNIT : mm
1mm = 0.03937 inch

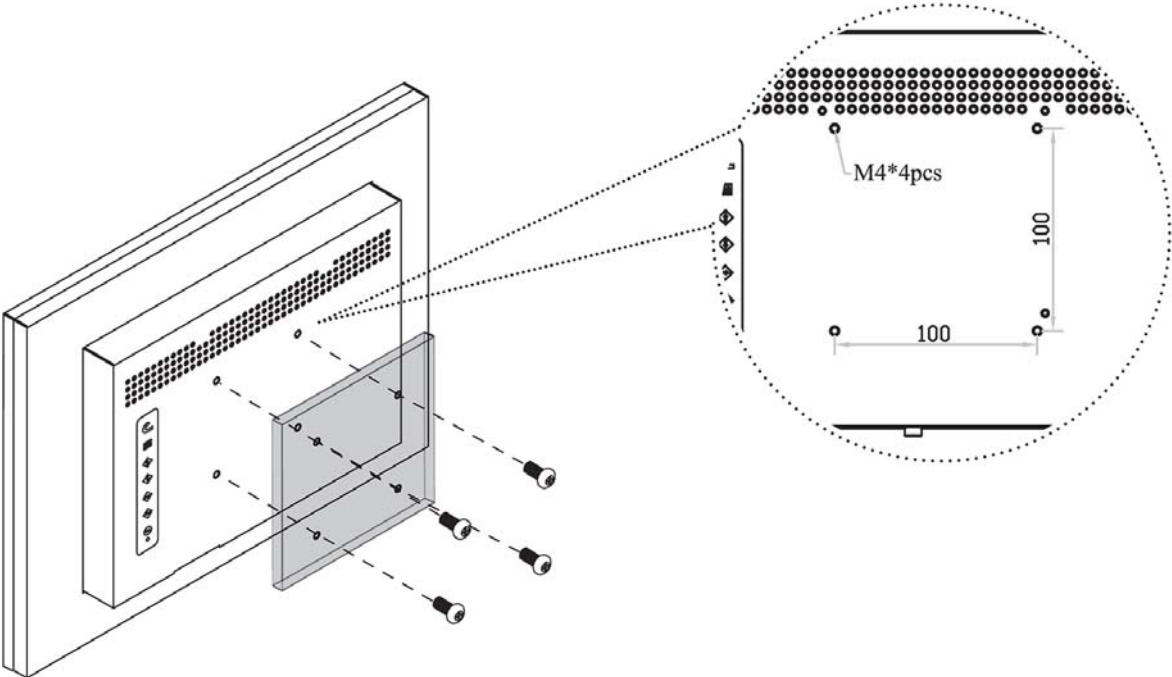

Remarks

- Hardware and M4*4 pcs for VESA mounting is not provided