

iDP-4000AW Mounting Method

UNIT : mm
1mm = 0.03937 inch

100mm VESA standard

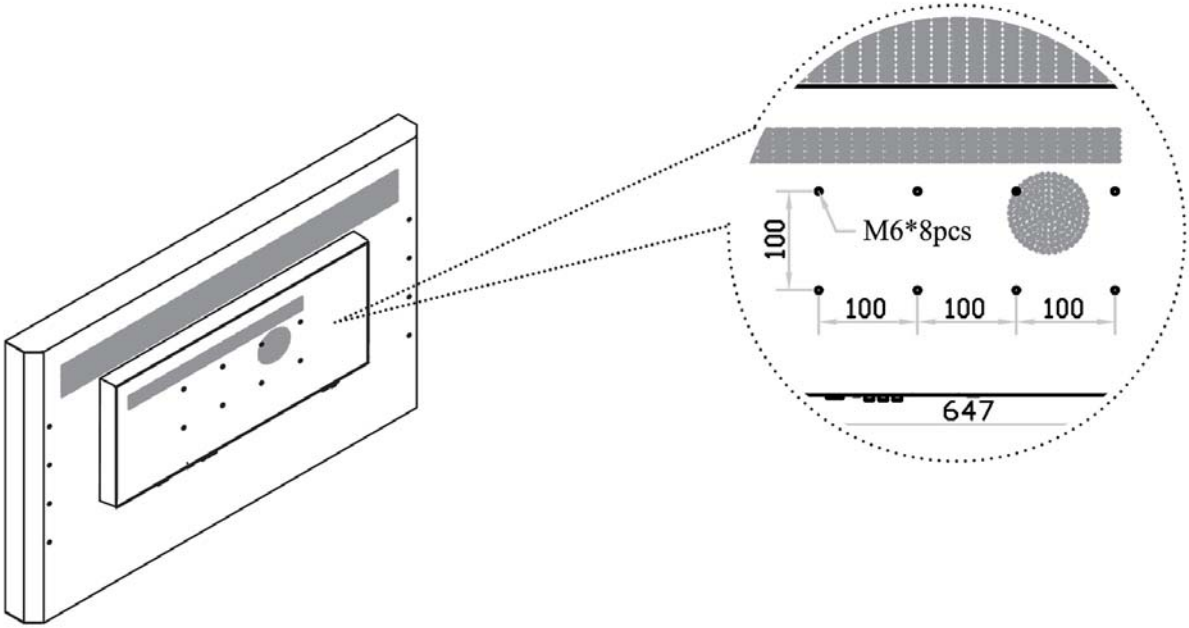

Remarks

- Hardware and M6*8pcs for VESA mounting is not provided