



iNAP-2000 Mounting Method

Mounting bracket A

1



x 4 pcs

Mounting bracket A

2



x 4 pcs

M4*6mm screw

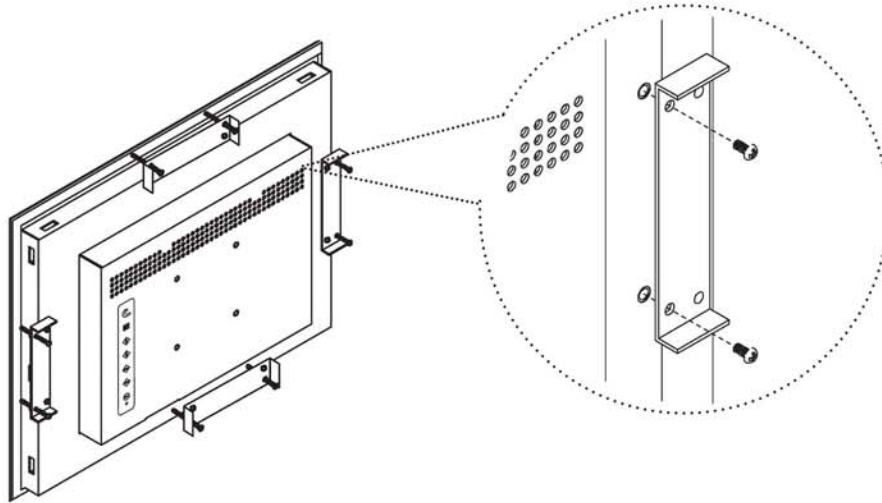

Mounting bracket B

3



x 12 pcs

Mounting bracket B

4



x 12 pcs

M4*50mm screw

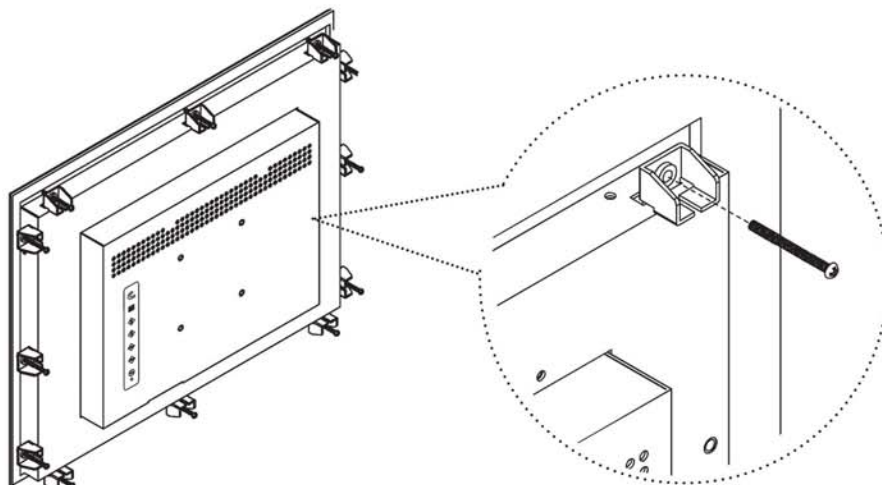



iNAP-2000 Mounting Method

100mm VESA standard

UNIT : mm

1mm = 0.03937 inch

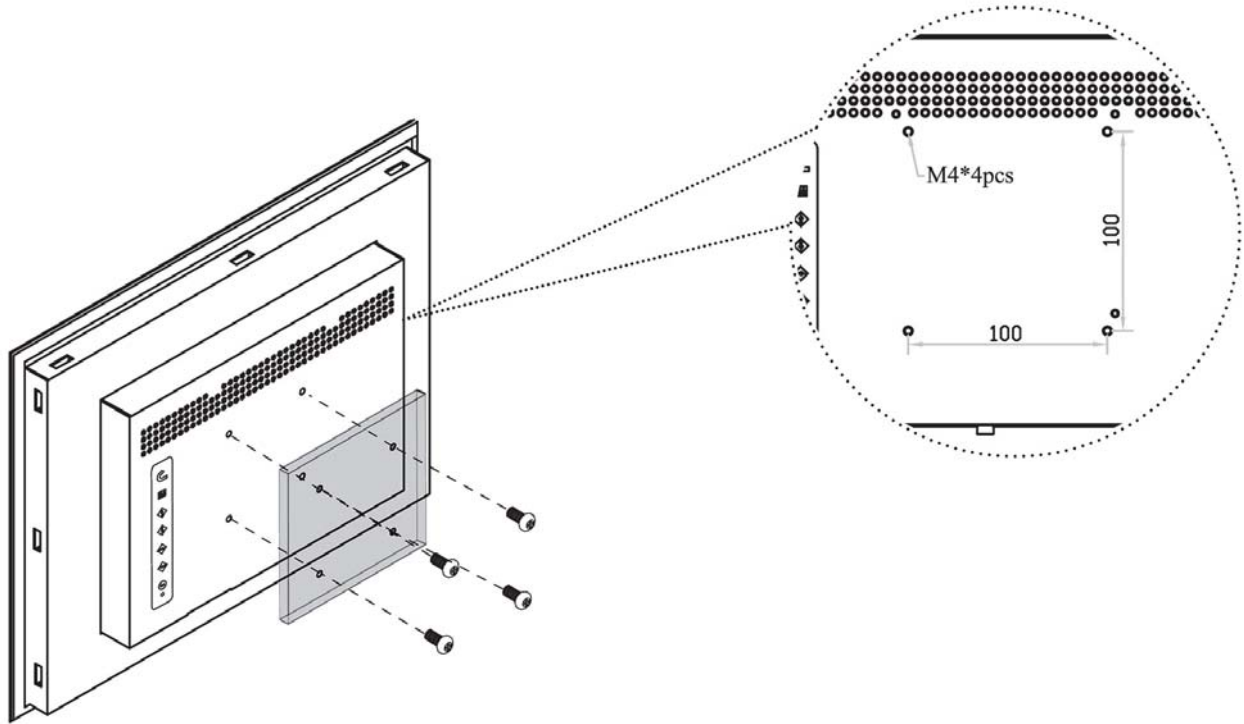

Remarks

- Hardware and M4*4 pcs for VESA mounting is not provided