

OPEN FRAME LED MONITOR

Open Frame 19" TFT LCD Black Panel Mount Rear
Wide display Resolution 1440x900, Brightness: 250nits
VGA + DVI-D

MODEL: iOP-W1900

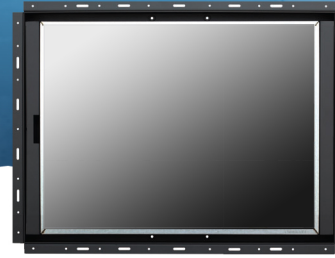

KEY BENEFITS

- 1440x900 native resolution
- 16.7 M colors
- DVI-D + VGA video input
- Video decoding capability up to 1080p (option)
- Rugged structure ensures high mobility
- Professional-use durability & around-the-clock operation
- 2-year standard warranty (upgradable up to 5 years)

APPLICATIONS

- Broadcasting/Advertising
- Traffic control / Command center
- Directory / Ticket kiosk
- Surveillance system
- Vehicle mount display
- Bathroom TV

OPTIONS

- DC power
- Touchscreen
- IP65 front protection
- Custom chassis & mounting
- Sunlight readable panel
- Multi monitor OSD control module
- 3G/HD/SD-SDI input module
- Auto dimming
- Manual dimming

OPTIONS - TOUCHSCREEN & GLASS PROTECTION

GLASS Protection	
Anti-reflective Glass	Optional
Vandal Proof Glass	Optional

e-Resistive 1-point Touch	
Technology	5-Wire Resistive
Touch Point	Single
Input Type	Finger or Stylus
Resolution	2048 x 2048
Response Speed	15 ms
Activation Force	<50g
Surface Hardness	3H
Light Transmission	80% ± 3%
Haze	8% ± 3%
Durability	10 million touches
Top Layer	ITO Film
Bottom Layer	ITO Glass
Thickness	3.2 ±0.2 mm
Connector	USB Type A
Compatibility	Windows 7 / XP / Linux / Mac

OPTIONS – DC POWER

		12V	24V	48V	125V
Input rating	Input voltage	12-Volt	24-Volt	48-Volt	110-Volt
	Input range	9-18V	18-36V	36 ~ 75V	66-160V
Input current	No load	50 mA	50 mA	50 mA	35 mA
	Full load	4950 mA	2450 mA	1220 mA	749 mA
Output rating	Output voltage	12-Volt	12-Volt	12-Volt	12-Volt
	Output current	4.16A	4.16A	4.16A	6.25A
Efficiency		84%	85%	85%	91%

OPTIONS – VIDEO MANAGEMENT & TRANSMISSION OVER NETWORK

Embedded Multi Monitor OSD Control Module over serial

- Remote control the monitor OSD via RS-232C serial interface
- Daisy chain up to 64 monitors via Cat5/6 cable
- Individual ID for individual monitor OSD settings
- Power ON or OFF monitor
- Adjust brightness & audio
- Switch video sources

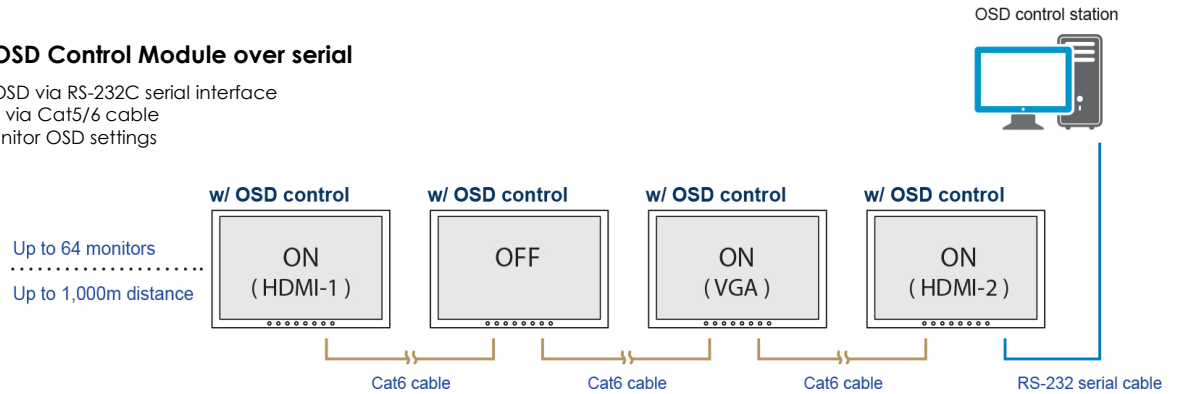

Embedded 3G / HD / SD-SDI Input Module

- Intelligent SDI monitoring with broadcast quality scopes
- Supports multi-rate 3G / HD / SD-SDI format
- Provides input to output loop-through capability
- Auto format sensing & selection

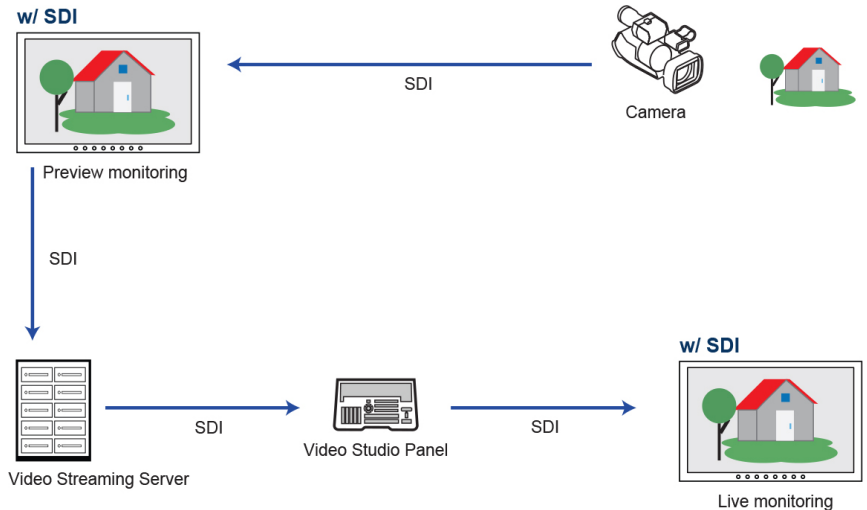

Embedded Manual Brightness Dimming Knob

- Easy-to-use IP54 dimming knob on the front panel
- One click causes 2% brightness increase or decrease
- Brightness adjustment from 0% to 100%

Embedded Auto Brightness Dimming Module

- Brightness changes according to its ambient brightness
- Its brightness change causes 10% increase or decrease

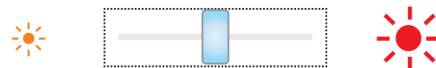

Embedded HDMI Decoder Module 1080p over IP

- Decodes RTSP, RTMP, UDP, HTTP, HLS protocols
- Supports video resolutions up to 1080p / 60Hz
- Unicast and multicast support
- Operates on standard 1000Mb Ethernet networks
- Excellent image quality with very low delay
- Built-in Web UI for configuration and control

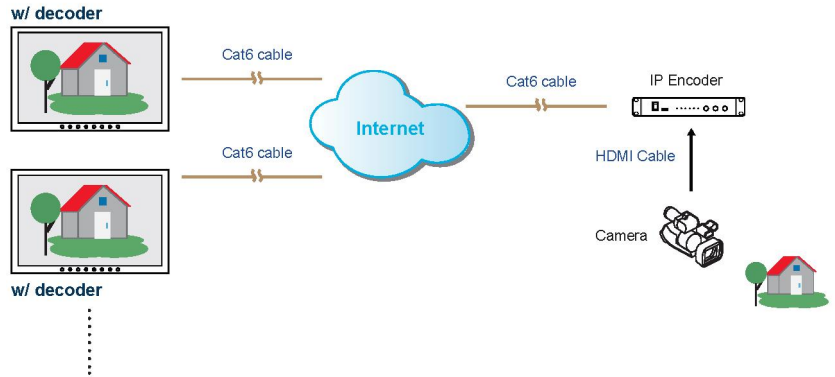

Embedded HDMI Receiver Module 1080p

- Extends the HDMI signal over a single Cat5/6 cable
- Supports video resolutions up to 1080p / 60Hz
- One to one just via Cat5/6 cable
- One to multi via network hub and Cat5/6 cable
- 100m maximum Cat5/6 cable distance
- Supports bi-directional IR communication
- High Speed HDMI 1.4 and HDCP 1.4 compliant

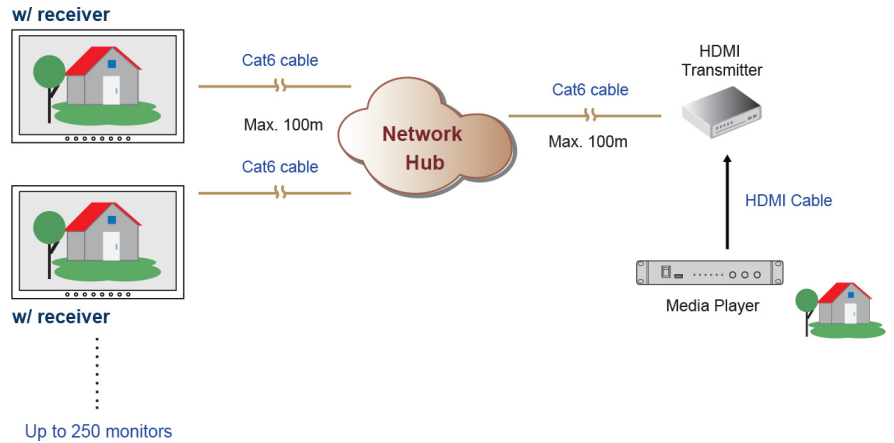

Embedded HDMI Quad Display Module 1080p

- Allows 4 x HDMI inputs to be monitored simultaneously
- Quad split, panel left and full screen monitoring modes
- High speed HDMI 1.4 and HDCP 1.4 compliant
- Supports video resolutions up to 1080p / 60Hz
- Supports Scaler Up and Down function
- Control via local front panel and IR remote

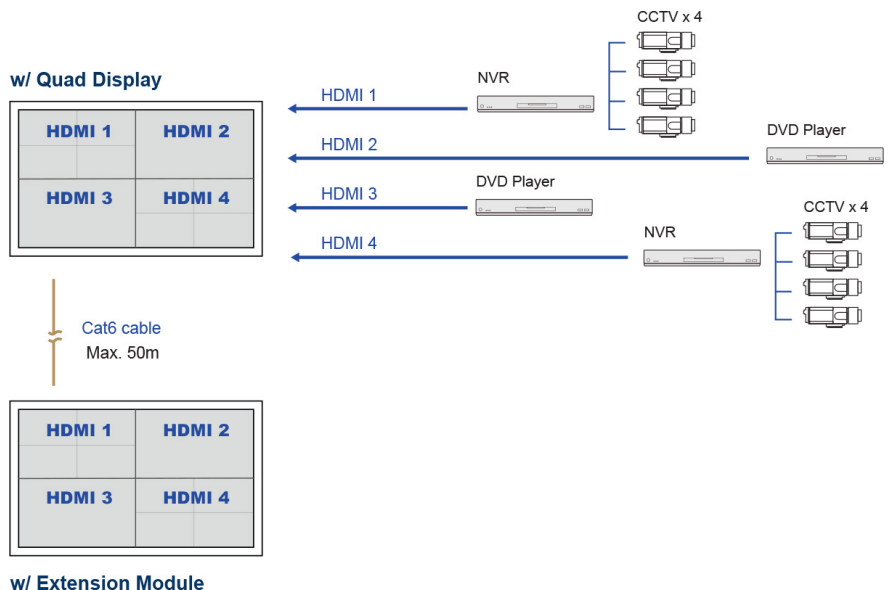

SPECIFICATIONS

LCD Panel	
Panel size (diagonal)	W19"
Native resolution	1440x900
Brightness (cd/m ²)	250
Contrast ratio (typ.)	1000:1
Colors	16.7 M
Viewing angle (L/R/U/D)	85/85/80/80
Response time (ms)	5
Dot pitch (mm)	0.2835
Display area (mm)	408.24H x 255.15V
Surface treatment	Anti-glare
Surface hardness	3H
Backlight type	LED
MTBF (hrs)	30,000

Mounting	
VESA mount	100 x 100 mm
Universal Mount	[ready]
Overhead tilted wall-mount	[optional]
Desktop stand	[optional]

Power	
Input	Auto-sensing 100 to 240VAC, 50 / 60Hz
Max. Consumption :	
Screen on	20W
Saving mode	4W
Button off	1W

Design	
Protection	Open frame
Front panel	Black, RAL 9005
Rear casing	Black, RAL 9005

Video	
VGA	Analog 0.7Vp-p
DVI	DVI-D single link

Video Option	
HDMI	HDMI 1.2/HDCP1.1
Composite (BNC)	NTSC & PAL
S-Video (4-pin)	NTSC & PAL

Audio Option	
Audio input:	
Connector	3.5mm stereo jack
Impedance / Power level	30kn / 750mV
Audio output:	
Connector	3.5mm stereo jack
Resistance / Power level	30kn / 2.8V
Speaker:	
Dual stereo speaker	2Wx2

VGA / DVI input	
PC signal	1440 x 900 x 60Hz 1280x1024x60/75Hz 1280 x960 x60Hz 1280x768x60/75Hz 1152 x864 x75Hz 1024x768x60/70/75Hz 848 x 480 x 60Hz 800 x 600 x 60 / 72 / 75Hz 720 x 400 x 70Hz 640 x 480 x 60 / 72 / 75Hz 640 x 400 x 70Hz 640 x 350 x 70Hz
Audio signal	2ch Linear PCM

HDMI input	
PC signal	Same as VGA
HDMI 1.3/1.2	1280 x 720 x 50 / 60Hz (720p) 720 x 480 x 50 / 60Hz (576p / 480p)
Audio signal	2ch Linear PCM

**Specifications subject to change without notice, not responsible for typographical errors.*

Environment	
Operating temp.	0 to 55°C degree
Storage temp.	-20 to 60°C degree
Operating humidity	10~90%, non-condensing
Storage humidity	5 ~90%, non-condensing
Operating altitude	16,000 ft
Non-operating altitude	40,000 ft
Shock	10G acceleration (11 ms duration)
Vibration	10~300Hz 0.5G RMS random

Compliance	
EMC	FCC & CE
Safety	CE/LVD&UKCA
Environment	REACH &RoHS3/WEEE

PHYSICAL DIMENSION & WEIGHT

Product (W x D x H):	mm/inch	505.5 x 59.6 x 335.1 / 19.9 x 2.3 x 13.2
Net weight		5.5 kg / 12.1 lb
Packing(WxDxH):	mm/inch	662 x 115 x 533 / 26.1 x 4.5 x 21
Gross weight		8.4 kg / 18.5 lb

STRUCTURE DIAGRAM

