

RUGGEDIZED LCD DISPLAY

7" High Brightness Rugged Full IP65 Dust/Water Resistant Protection with Projected Capacitive Multi-Touch (P-CAP)

MODEL: WRD0700PHB-TFP



PRODUCT FEATURES:

- 7" 1024 x 600 Resolution
- Projected Capacitive Multi-Touch (P-Cap)
- Front IP65 Water and Dust Proof
- VGA input and variety of optional connectors
- USB port for touch
- Stylish and elegant design

PRODUCT SPECIFICATIONS:

Resolutions	7" TFT
Active Display Area(mm)	153.6 (H) x 90 (V)
Display Resolution	1024 x 600
Pixel Pitch(mm)	0.15 (H) x 0.15 (V)
Recommended Resolution	1024 x 600 @60Hz
Contrast Ratio	700:1 (typ.)
Brightness(cd/m)	1000 cd/m ² (typ.)
Viewing Angle(CR>=10)	-75~75 (H); -75~70 (V)
Power Source	12V DC (M12 type)
Power Consumption	10 W typical, normal operation
Power Management	VESA DPMS Compliant
Plug & Play	Yes
Input Ports	1 x VGA, 1 x USB for Touch
Touch Screen	Projective Capacitive Touch(USB) (optional protection glass)
Operating Temperature	-15°C~55°C
Storage Temperature	-30°C~70°C
Operating Humidity	10%~95% (non-condensing)
IP Rating	Full IP65
Shock Operating	30g for 18ms, 300m/s ²
Vibration Operating	1.60/1.96/2.18 g rms for XYZ/ 5-500Hz
Certifications & Standards	Compliant with MIL-STD-810F/G for vibration / shock, CE, FCC

I/O VIEW:

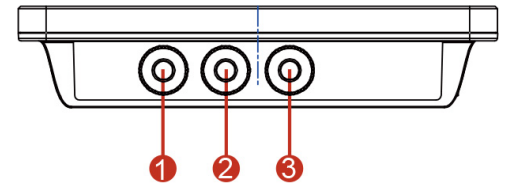

1. 12V DC (M12 type)
2. VGA (M12 type)
3. USB For Touch(M12 type),
only with Touch
4. OSD Power

MECHANICAL DRAWING:

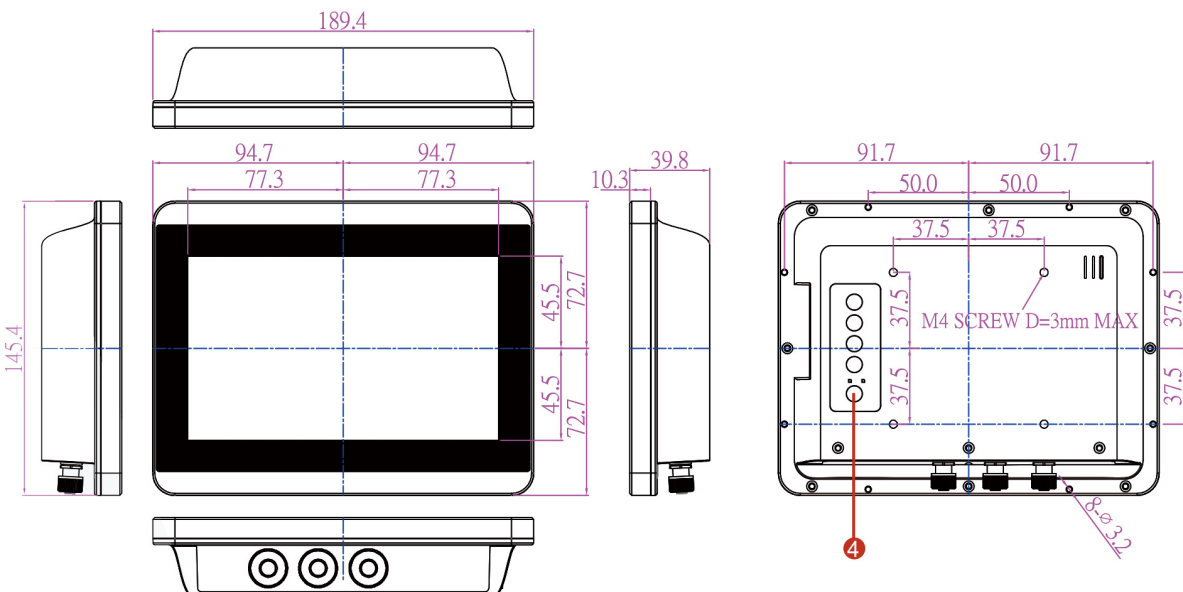

M12 Power Cable

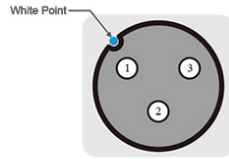
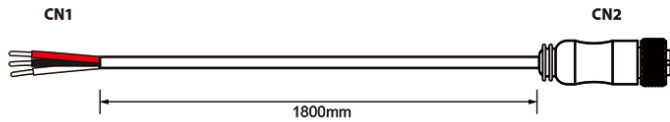

Pin No.	Symbols	Color		Pin No.	Symbols	Color
CN1-1	VCC+	Red	↔	CN2-1	VCC+	Red
CN1-2	GND	Black	↔	CN2-2	GND	Black
CN1-3	VCC-	White	↔	CN2-3	VCC-	White

VGA Cable

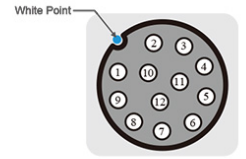
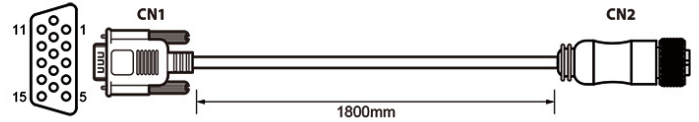

Pin No.	Symbols	Color		Pin No.	Symbols	Color
CN1-1	R	Red	↔	CN2-1	R	Red
CN1-6	R-GND	Black	↔	CN2-2	R-GND	Black
CN1-5	G	Green	↔	CN2-3	G	Green
CN1-7	G-GND	Black	↔	CN2-4	G-GND	Black
CN1-3	B	Blue	↔	CN2-5	B	Blue
CN1-8	B-GND	Black	↔	CN2-6	B-GND	Black
CN1-12	SDA	Yellow	↔	CN2-7	SDA	Yellow
CN1-13	HS	Orange	↔	CN2-8	HS	Orange
CN1-14	VS	White	↔	CN2-9	VS	White
CN1-15	SCL	Brown	↔	CN2-10	SCL	Brown

} coaxial
} coaxial
} coaxial

USB for Touch Cable

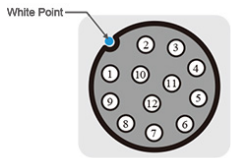

Pin No.	Symbols	Color		Pin No.	Symbols	Color
CN1-2	VCC	Red	↔	CN2-1	VCC	Red
CN1-3	D-	White	↔	CN2-2	D-	White
CN1-4	D+	Green	↔	CN2-3	D+	Green
CN1-5	GND	Black	↔	CN2-4	GND	Black
CN1-9	GND	Black	↔	CN2 Shell	Black	

} twisted pairs