

Full IP67 Chassis Mount Dust and Waterproof LCD



IP67 Chassis 10.1" Wide LCD monitor, 1920 x 1200, LED 400 nits, VGA input, wide viewing angle, w/o Speaker, w/ Ext. Adapter, IP67 cables, SECC Metal w/ Powder coating with 10 points Projective Capacitive Touch (1-2mm) USB Controller
(Model: ECH7-W1010CWV-PCT10)





 Immersion Protected (up to 1 meter)	 Vibration Safeguards	 Shock Safeguards	 Low Power	 Wide Viewing
--	--	--	--	--

Features:

- Modular mechanism design provides flexible product configuration and easy maintenance.
- Optional to built-in touch screen for interactive application.
- Available with auto-brightness sensor offers application in day and night.
- SECC + Powder coating
- Complete custom design/solution for OEM customers
- IP67 Compliant
- Protected against temporary immersion (up to 1 meter for 30 minutes)
- MIL-STD Compliant Connector

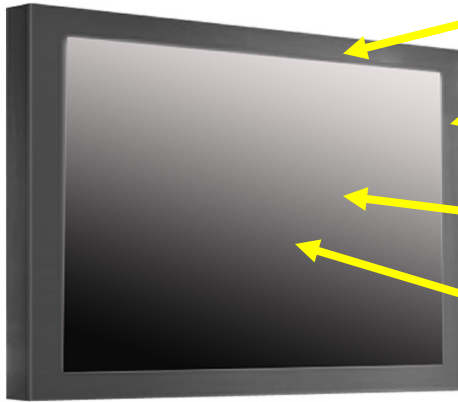
Rugged Completely Sealed IP67/NEMA6 Chassis/Surface Mount LCD Monitor

	<p>Water Proof Solution, Full IP NEMA6 Rating front and back</p> <p>Aluminum Housing Chassis Design</p>	<p>* IP67 Water and Dust proof connection for a higher protection</p> <p>* All Connectors are facing backward</p> 
	<p>AR Glass Protective Glass at front</p> <p>Optional High Brightness and Touch screen</p>	



Specification:

Panel	Cell Type / Glass Surface	TFT LCD / Black Anti-Glare, low reflection coating	
	Aspect Ratio / Size	Wide / 10.1" viewable diagonal area	
	Active Area / Pixel Pitch	216.81(H) x 135.5(V) mm / 0.113(H) x 0.113(V) mm	
	Native Resolution / Colors	1920(H) x 1200(V) / 16.7M	
	Brightness / Contrast	400 cd/m ² (typ) / 600 : 1	
	Response Time	≤ 25 ms	
	Viewing Angle (typical)	H. 178o (- 89o ~ + 89o) , V. 178o(- 89o ~ + 89o)	
	Light Source	LED backlight, Long life, 35,000 hrs (typ)	
Input Sources	PC System	Signal	Analog RGB (0.7/1.0 V _{p-p} , 75 ohms)
		Sync	Separate Sync, Composite Sync, Sync On Green
		Frequency	F _h : 30 - 82Khz , F _v : 50 -75Hz
	Audio System	2W speaker x 2	
Input Terminals	1 x VGA (15 Pin Female D-Sub) , 1 x PC Audio (Stereo Headphone Jack) , 1 x DC Power Plug		
Convenient Features	Auto Calibration , Back Light Adjustment , Plug&Play (VESA DDC/CI, DDC 2B)		
	OSD Multi-Languages , Wall Mount Ready (VESA 75 x 75 mm)		
Power	Internal power supply with universal / Auto-Sensing, AC 90 to 260V, 50 / 60 Hz		
Power Consumption	Operation / Power Saving	3 watt , < 1 watt (Support DPMS)	
Operating Condition	Temperature / Humidity	0°C ~ 50°C (32°F ~ 122°F) , 10% ~ 90% (no condensation)	
Storage Condition	Temperature / Humidity	- 20°C ~ 60°C (- 4°F ~ 140°F) , 10% ~ 90% (no condensation)	
Certification	FCC , CE		
Dimensions	Physical	W x H x D = TBD	
	Carton	W x H x D = TBD	
Weight	N.W. / G.W.	2 Kgs / 3 Kgs	
Container Loaded	20ft / 40ft / 40ft HQ	TBD (Sets , By pallet)	

Options	Touch	Video / TV	Enhanced Panel	Others
	Resistive touch	SV + AV	Panel with LED backlight	Digital Signage(Stand alone)
	Capacitive touch	SV + AV + AV Looping	High brightness panel	Networking Digital Signage
	SAW touch	SV + AV + TV	Wide Temperature	Motion Sensor
	Infrared touch		Sunlight Readable	Light Sensor
	Protected glass			Auto-Dimming

Applications:

- Automation
- Batch Processing
- Commercial Broadcast Operations
- Man Machine Interface (MMI) Operation
- Electronic Flight Bag (EFB)
- Food Processing
- GPS Mapping Systems
- Inspection Systems

Mechanical Drawing:

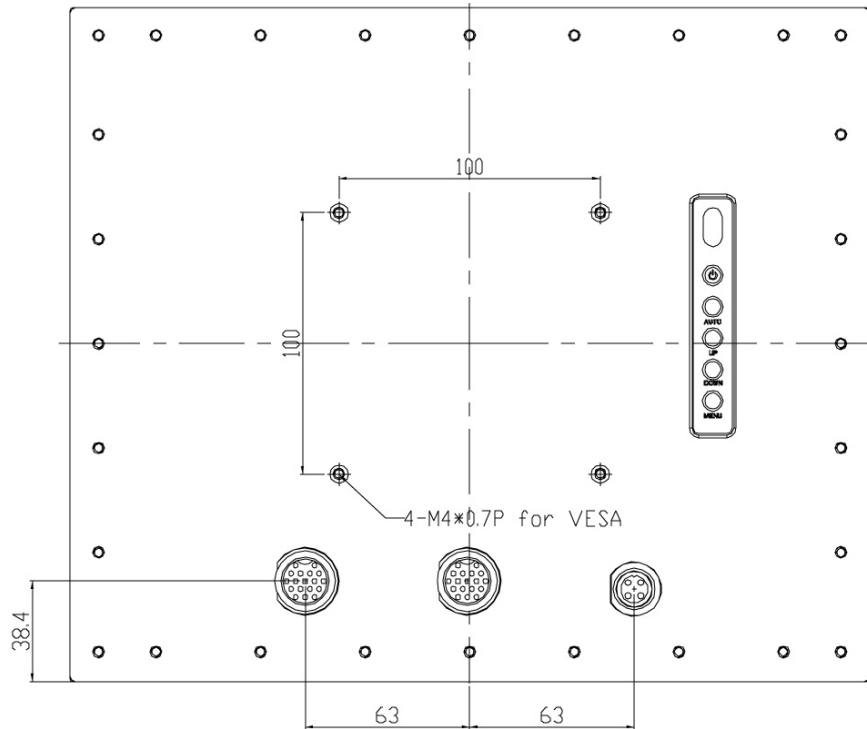
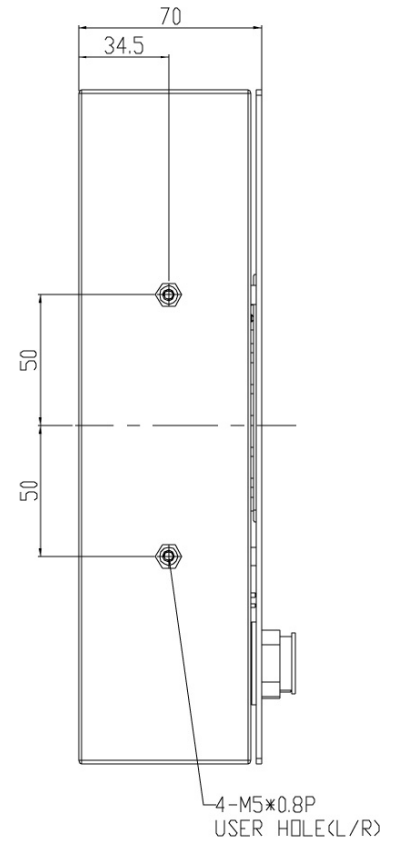
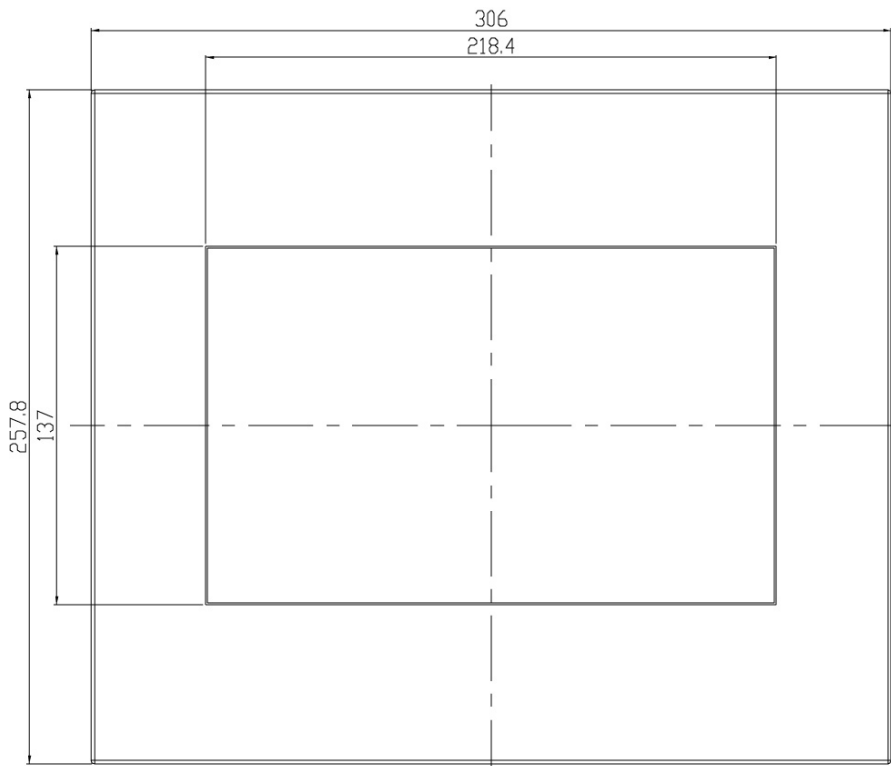

LCD Options:



LED Backlight Options

Introducing LED backlight options for monitors for energy efficiency and a brighter screen.



VIDEO Input Options:

For Video inputs options:

DVI, DVI+HDMI, SVideo+AV, SVideo+AV+DVI, AV+Looping, DVI+AV+Looping, HD-SDI, BNC(PAL/NTSC)



Optical Bonding Options

- Optical Bonding provides the best reduction of ambient light washout of any commercially available enhancement technology.
- Optical Bonding has a lower cost than most other competing technologies.
- Optical Bonding offers superior ruggedization, enhancing the display durability under vibration, shock and other environmental extremes.

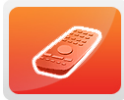

RS-232 Remote Control Options

Remote Control Protocol: Command Code to set system



9-36V DC Input Options

iTech offers a selection of DC input from 9V to 36V



Light Sensor and Motion Sensor Options

iTech LCD offers Light and Motion Sensor

Privacy Filter

Front Glass Options:

- Anti Reflective AR Glass 3mm
- Anti Reflective AR Glass 6mm Vandal-Resistance
- Anti Reflective AR Glass 8mm Vandal-Resistance
- Anti Glare AG Glass 3mm