

# EFMF Series Industrial Flush Mount LCD Monitor



Flush Mount (OSD front) 22" Wide LCD monitor, 1680 x 1050, LED  
250 nits, VGA input, WV(178°/178°)  
(Model: EFMFW2200WV)



**Vibration  
Safeguards**



**Shock  
Safeguards**



**Low  
Power**



**Wide  
Viewing**

## Features:

- Modular mechanism design provides flexible product configuration and easy maintenance.
- Optional to built-in touch screen for interactive application.
- Available with auto-brightness sensor offers application in day and night.
- Complete custom design/solution for OEM customers

## Industrial Rugged Flush Mount LCD Monitor

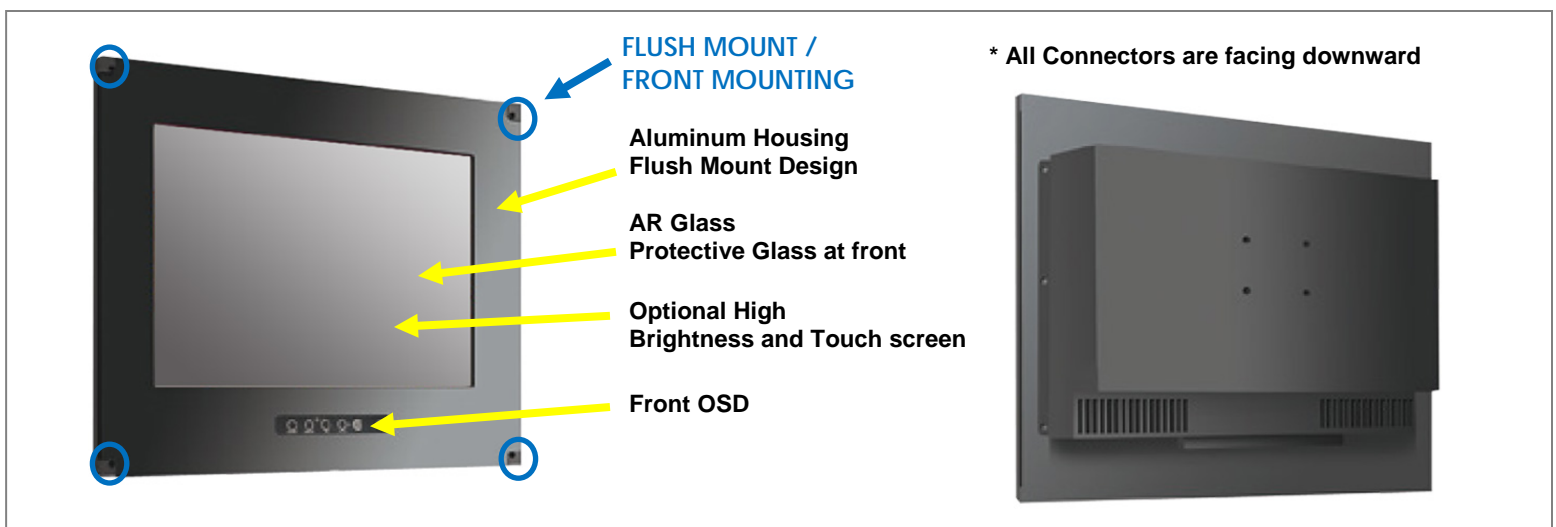

## Specification:

<b>Panel</b>	Cell Type / Glass Surface	TFT LCD / Black Anti-Glare, low reflection coating	
	Aspect Ratio / Size	Wide / 22" viewable diagonal area	
	Active Area / Pixel Pitch	473.8(H) x 296.1(V) mm / 0.282(H) x 0.282(V) mm	
	Native Resolution / Colors	1680(H) x 1050(V) / 16.7M	
	Brightness / Contrast	250 cd/m <sup>2</sup> (typ) / 2000 : 1	
	Response Time	≤ 20 ms	
	Viewing Angle (typical)	H.178° (- 89o ~ + 89o) , V. 178o(- 89o ~ + 89o)	
	Light Source	LED backlight, Long life, 35,000 hrs (typ)	
<b>Input Sources</b>	PC System	Signal	Analog RGB (0.7/1.0 V <sub>p-p</sub> , 75 ohms)
		Sync	Separate Sync, Composite Sync, Sync On Green
		Frequency	F <sub>h</sub> : 30 - 82Khz , F <sub>v</sub> : 50 -75Hz
	Audio System	2W speaker x 2	
<b>Input Terminals</b>	1 x VGA (15 Pin Female D-Sub) , 1 x PC Audio (Stereo Headphone Jack) , 1 x DC Power Plug		
<b>Convenient Features</b>	Auto Calibration , Back Light Adjustment , Plug&Play (VESA DDC/CI, DDC 2B)		
	OSD Multi-Languages , Wall Mount Ready (VESA Dimension - please refer to Drawing)		
<b>Power</b>	External AC-to-12VDC power adapter with universal / Auto-Sensing, AC 90 to 260V, 50 / 60 Hz		
<b>Power Consumption</b>	Operation / Power Saving	24.7 watt , < 1 watt (Support DPMS)	
<b>Operating Condition</b>	Temperature / Humidity	0°C ~ 50°C (32°F ~ 122°F) , 10% ~ 90% (no condensation)	
<b>Storage Condition</b>	Temperature / Humidity	- 20°C ~ 60°C (- 4°F ~ 140°F) , 10% ~ 90% (no condensation)	
<b>Certification</b>		FCC , CE	
<b>Dimensions</b>	Physical	Please refer to Drawing	
	Carton	W x H x D = TBD	
<b>Weight</b>	N.W. / G.W.	9 Kgs / 10.5 Kgs	
<b>Container Loaded</b>	20ft / 40ft / 40ft HQ	TBD (Sets , By pallet)	

Options	Touch	Video / TV	Enhanced Panel	Others
	Resistive touch	SV + AV	Panel with LED backlight	Digital Signage(Stand alone)
	Capacitive touch	SV + AV + AV Looping	High brightness panel	Networking Digital Signage
	SAW touch	SV + AV + TV	Wide Temperature	Motion Sensor
	Infrared touch		Sunlight Readable	Light Sensor
	Protected glass			Auto-Dimming

## Applications:

- Automation
- Batch Processing
- Commercial Broadcast Operations
- Man Machine Interface (MMI) Operation
- Electronic Flight Bag (EFB)
- Food Processing
- GPS Mapping Systems
- Inspection Systems

Mechanical Drawing:

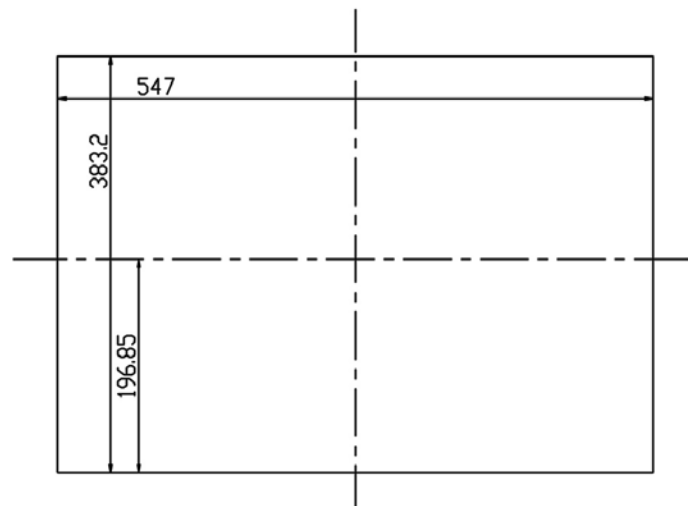
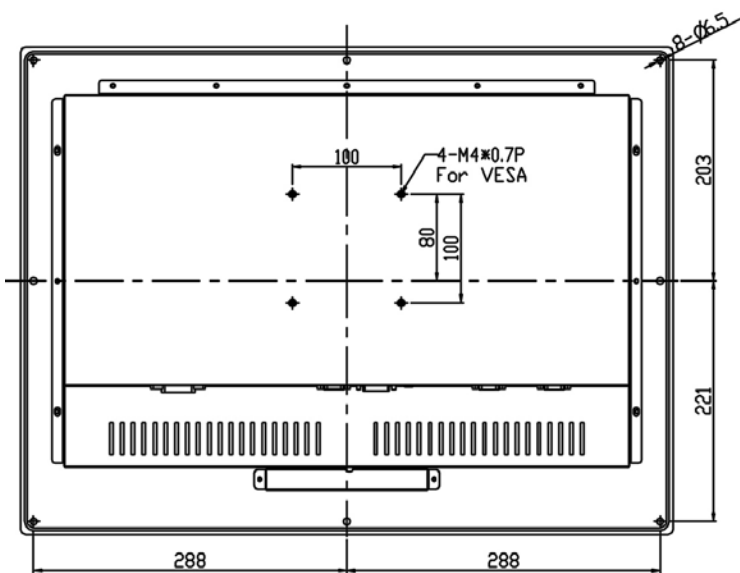
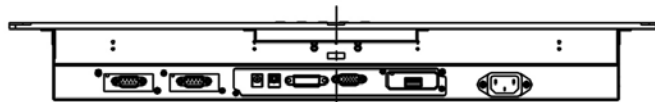
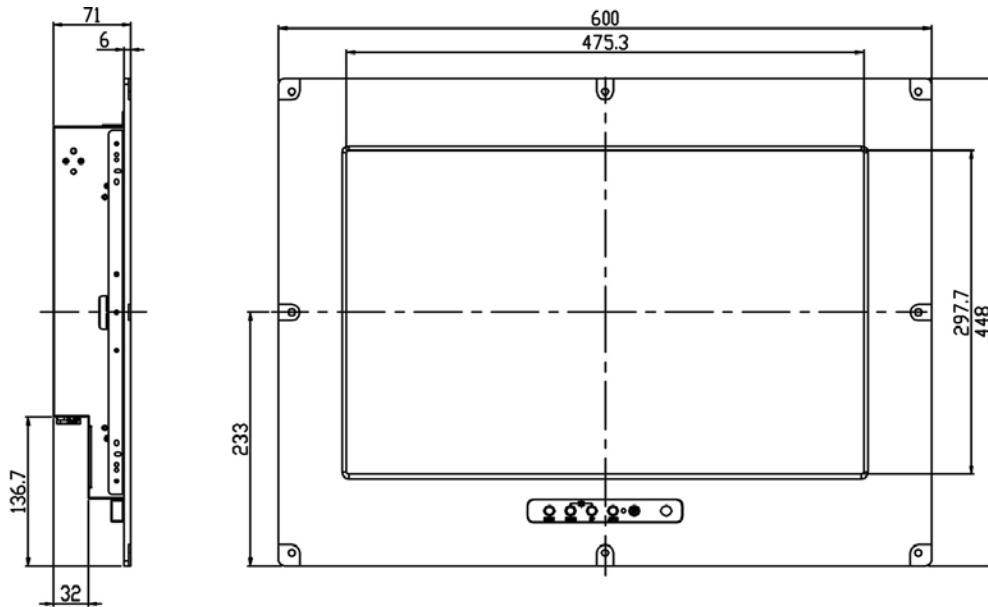

## LCD Options:



### LED Backlight Options

Introducing LED backlight options for monitors for energy efficiency and a brighter screen.



### VIDEO Input Options:

For Video inputs options:

DVI, DVI+HDMI, SVideo+AV, SVideo+AV+DVI, AV+Looping, DVI+AV+Looping, HD-SDI, BNC(PAL/NTSC)

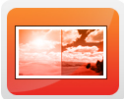

### Optical Bonding Options

- Optical Bonding provides the best reduction of ambient light washout of any commercially available enhancement technology.
- Optical Bonding has a lower cost than most other competing technologies.
- Optical Bonding offers superior ruggedization, enhancing the display durability under vibration, shock and other environmental extremes.



### RS-232 Remote Control Options

**Remote Control Protocol: Command Code to set system**



### 9-36V DC Input Options

iTech offers a selection of DC input from 9V to 36V

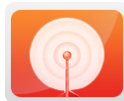

### Light Sensor and Motion Sensor Options

iTech LCD offers Light and Motion Sensor

### Privacy Filter

Front Glass Options:

- Anti Reflective AR Glass 3mm
- Anti Reflective AR Glass 6mm Vandal-Resistance
- Anti Reflective AR Glass 8mm Vandal-Resistance
- Anti Glare AG Glass 3mm