

EPPM Series: IP65 Panel Mount

IP65 Panel Mount 8.4" LCD monitor, 800 x 600, LED 1000 nits, VGA input, WT(-30°C~80°C) with Resistive touch screen

Model: EPPM0840HBWT-TR



FEATURES HIGHLIGHTS:

- Modularize mechanical design provides flexible product configuration and easy maintenance
- Optional build-in touch screen for interactive application
- Available with auto-brightness sensor offers application in day and night
- VGA connector with optional AV.SV.AV-Looping
- Complete custom design/solution for OEM customers
- IP65 front side sealed for water-dust proof

SPECIFICATIONS:

Panel	Cell Type / Glass Surface	TFT LCD / Black Anti-Glare, low reflection coating	
	Aspect Ratio / Size	4 : 3 / 8.4" viewable diagonal area	
	Active Area / Pixel Pitch	170.4(H) x 127.8(V) mm / 0.213(H) x 0.213(V) mm	
	Native Resolution / Colors	800(H) x 600(V) / 262 K	
	Brightness / Contrast	1000 cd/m ² (typ) / 600 : 1	
	Response Time	< 30 ms	
	Viewing Angle (typical)	H. 160o (- 80o ~ + 80o) , V. 140o(- 70o ~ + 70o)	
	Light Source	LED backlight, Long life, 35,000 hrs (typ)	
Input Sources	PC System	Signal	Analog RGB (0.7/1.0 V _{p-p} , 75 ohms)
		Sync	Separate Sync, Composite Sync, Sync On Green
		Frequency	F _h : 30 - 82Khz , F _v : 50 -75Hz
	Audio System	2W speaker x 2	
Input Terminals	1 x VGA (15 Pin Female D-Sub) , 1 x PC Audio (Stereo Headphone Jack) , 1 x DC Power Plug		
Convenient Features	Auto Calibration , Back Light Adjustment , Plug&Play (VESA DDC/CI, DDC 2B)		
	OSD Multi-Languages , Wall Mount Ready (VESA Dimension - please refer to Drawing)		
Power	12V DC in		
Power Consumption	Operation / Power Saving	9 watt , < 2 watt (Support DPMS)	
Operating Condition	Temperature / Humidity	-30°C~80°C (-22°F ~ 176°F) , 10% ~ 90% (no condensation)	
Storage Condition	Temperature / Humidity	-30°C~80°C (-22°F ~ 176°F) , 10% ~ 90% (no condensation)	
Certification		FCC , CE	
Dimensions	Physical	Please refer to Drawing	
	Carton	W x H x D = TBD	
Weight	N.W. / G.W.	2.5 Kgs / 3.5 Kgs	
Container Loaded	20ft / 40ft / 40ft HQ	TBD (Sets , By pallet)	

Options	Touch	Video / TV	Enhanced Panel	Others
	Resistive touch	SV + AV	Panel with LED backlight	Digital Signage(Stand alone)
	Capacitive touch	SV + AV + AV_Looping	High brightness panel	Networking Digital Signage
	SAW touch	SV + AV + TV	Wide Temperature	Motion Sensor
	Infrared touch		Sunlight Readable	Light Sensor
	Protected glass			Auto-Dimming

MECHANICAL DRAWING:

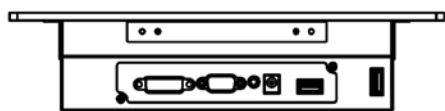
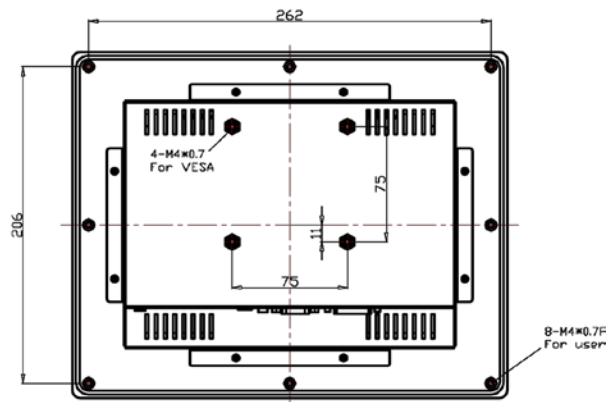
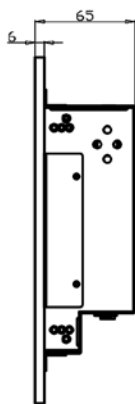
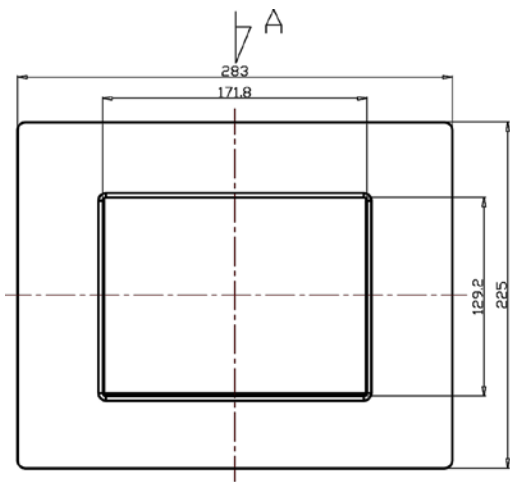

VIEW A

