

1000nits

Wide Marine Bridge System Front IP65 Panel Mount Display High brightness

EMA Series

15.4" LCD monitor, 1280x800, LED-1000nits, HDMI, VGA, BNC-in x 2, BNC-looping x 2, (PIP), Wide Temp. (-30~80°C), DC 9-36V Input and Front OSD control Brightness 0~100%, OSD Remote Control via RS-232, including rear screw/Clamp/VESA Mount

Model: EMAW1540WT

With PIP, IP65 [Front], Wide Temp., Dimming, OSD Front Panel, Wide Voltage Input and High Brightness



FEATURES:

- Membrane "+" & "-" Front OSD Direct control backlight brightness from nearly 0% to 100%
- High brightness/Sunlight Readable LED 100nits panel
- With PIP, IP65 [Front], Wide Temp., Dimming, OSD Front Panel, Wide Voltage Input and High Brightness
- 9 to 36V DC power input
- Panel (flush) mount IP65 aluminum 6mm Bezel with powder coating design (IP54 rear)
- RS232 remote monitoring
- Optional of Resistive/Capacitive/SAW/PCT touchscreen
- Optional of 3mm/6mm (Safety) AR protection glass
- Optional M12 Plastic Water proof connectors
- Optional with Bracket stand
- Optional for 90-260V AC input

HIGHLIGHTS FEATURES:

Membrane "+" & "-" Front OSD Direct control backlight brightness from nearly 0% to 100%

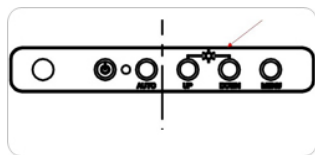

9 to 36V DC power input



Optional M12 Plastic Water proof connectors



SPECIFICATIONS:

Panel	Cell Type / Glass	TFT LCD / Black Anti-Glare, low reflection coating	
	Aspect Ratio / Size	Wide / 15.4" viewable diagonal area	
	Active Area / Pixel	331.2(H) x 207.0(V) mm / 0.2588(H) x 0.2588(V) mm	
	Native Resolution /	1280(H) x 800(V) / 262 K	
	Brightness / Contrast	1000 cd/m ² (typ) / 450 : 1	
	Response Time	≤ 15 ms	
	Viewing Angle (typical)	H. 90o (- 45o ~ + 45o) , V. 50o(- 30o ~ + 20o)	
Input Sources	PC System	Signal	Analog RGB (0.7/1.0 V _{p-p} , 75 ohms)
		Sync	Separate Sync, Composite Sync, Sync On
		Frequency	F _H : 30 - 82Khz , F _V : 50 -75Hz
	Audio System	2W speaker x 2	
Input Terminals	1 x VGA (15 Pin Female D-Sub) , 1 x PC Audio (Stereo Headphone Jack) , 1 x DC Power		
Convenient Features	Auto Calibration , Back Light Adjustment , Plug&Play (VESA DDC/CI, DDC 2B)		
	OSD Multi-Languages , Wall Mount Ready (VESA 75 x 75 mm)		
Power	9-36VDC wide voltage input (Isolated DC-DC voltage regulator built-in)		
Power Consumption	Operation / Power	28 watt , < 1 watt (Support DPMS)	
Operating Condition	Temperature / Humidity	0°C ~ 50°C (32°F ~ 122°F) , 10% ~ 90% (no condensation)	
Storage Condition	Temperature / Humidity	- 20°C ~ 60°C (- 4°F ~ 140°F) , 10% ~ 90% (no condensation)	
Certification	FCC , CE		
Dimensions	Physical	W x H x D = 450 x 330 x 64 mm	
	Carton	W x H x D = TBD	
Weight	N.W. / G.W.	4.5 Kgs / 5.5 Kgs	
Container Loaded	20ft / 40ft / 40ft HQ	TBD (Sets , By	

Options	Touch	Video / TV	Enhanced Panel	Others
	Resistive touch	SV + AV	Panel with LED	Digital Signage(Stand
	Capacitive touch	SV + AV + AV	High brightness panel	Networking Digital Signage
	SAW touch	SV + AV + TV	Wide Temperature	Motion Sensor
	Infrared touch		Sunlight Readable	Light Sensor
	Protected glass			Auto-Dimming

LCD OPTIONS



Optical Bonding Options

- Optical Bonding provides the best reduction of ambient light washout of any commercially available enhancement technology.
- Optical Bonding has a lower cost than most other competing technologies.
- Optical Bonding offers superior ruggedization, enhancing the display durability under vibration, shock and other environmental extremes.



RS-232 Remote Control Options

Remote Control Protocol: Command Code to set system



9-36V DC Input Options

iTech offers a selection of DC input from 9V to 36V

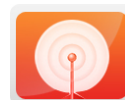

Light Sensor and Motion Sensor Options

iTech LCD offers Light and Motion Sensor

Privacy Filter

Front Glass Options:

- Anti Reflective AR Glass 3mm
- Anti Reflective AR Glass 6mm Vandal-Resistance
- Anti Reflective AR Glass 8mm Vandal-Resistance
- Anti Glare AG Glass 3mm

MECHANICAL DRAWING:

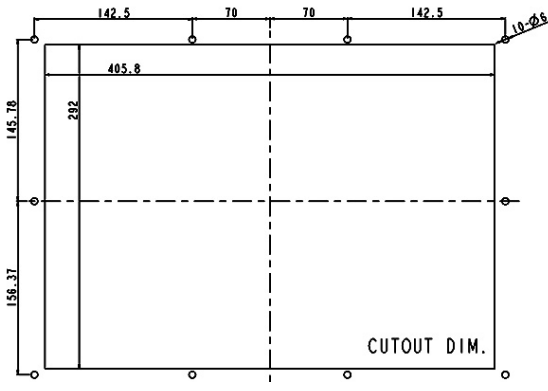
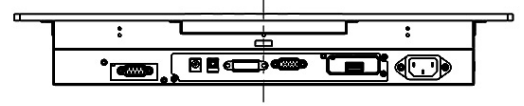
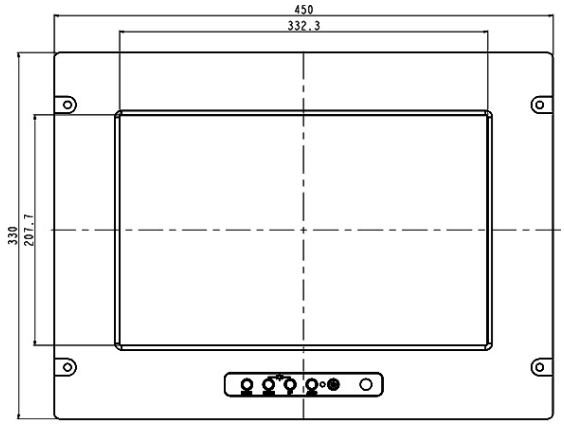
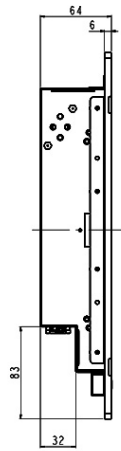
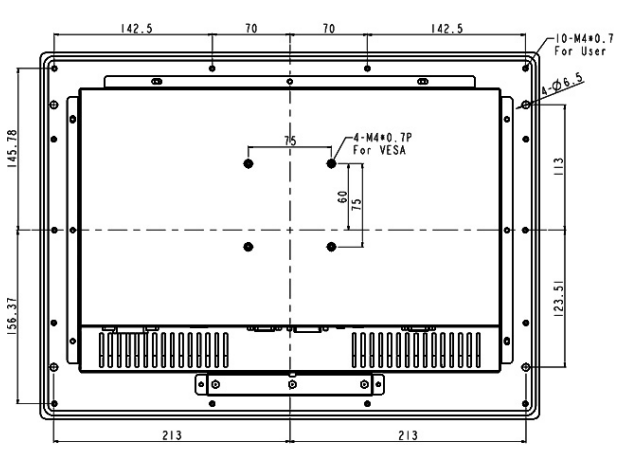

Option With Stand

