

1000nits



with Optical Bonding

12.1" LCD monitor, 800x600, LED-1000nits, VGA + DVI , Wide Viewing(178°/178° MVA), Wide Temperature(-30~70°C), DC 9-36V Input and Front OSD control Brightness 0~100%, OSD Remote Control via RS-232, including rear screw/Clamp/VESA Mount with Optical Bonding

Model: EMO1210

With PIP, IP65 [Front], Wide Temp., Dimming, OSD Front Panel, Wide Voltage Input, High Brightness and Optical Bonding



**FEATURES:**

- Optical Bonding has features such as superior ruggedization, enhancing the LCD surface durability under vibration and shock. Plus, No optical degradations due to solar, temperature and humidity.
- Membrane "+" & "-" Front OSD Direct control backlight brightness from nearly 0% to 100%
- High brightness/Sunlight Readable LED 1000nits panel
- With PIP, IP65 [Front], Wide Temp., Dimming, OSD Front Panel, Wide Voltage Input and High Brightness
- 9 to 36V DC power input
- Panel (flush) mount IP65 aluminum 6mm Bezel with powder coating design (IP54 rear)
- RS232 remote monitoring
- Optional of Resistive/Capacitive/SAW/PCT touchscreen
- Optional of 3mm/6mm (Safety) AR protection glass
- Optional M12 Plastic Water proof connectors
- Optional with Bracket stand
- Optional for 90-260V AC input

**HIGHLIGHTS FEATURES:**

*Membrane "+" & "-" Front OSD Direct control backlight brightness from nearly 0% to 100%*

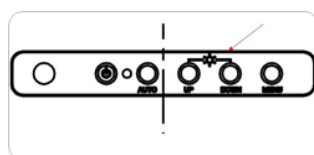

*9 to 36V DC power input*

*Optical Bonding*



*Optional M12 Plastic Water proof connectors*



## SPECIFICATIONS:

<b>Panel</b>	Cell Type / Glass	TFT LCD	
	Aspect Ratio / Size	4 : 3 / 12.1" viewable diagonal area	
	Active Area / Pixel	246.0(H) x 184.5(V) mm / 0.3075(H) x 0.3075(V) mm	
	Native Resolution /	800(H) x 600(V) / 262 K	
	Brightness / Contrast	1000 cd/m <sup>2</sup> (typ) / 600 : 1	
	Response Time	≤ 35 ms	
	Viewing Angle (typical)	H. 140o (- 70o ~ + 70o) , V. 120o(- 60o ~ + 60o)	
	Light Source	LED backlight, Long life, 35,000 hrs (typ)	
<b>Input Sources</b>	PC System	Signal	Analog RGB (0.7/1.0 V <sub>p-p</sub> , 75 ohms)
		Sync	Separate Sync, Composite Sync, Sync On
		Frequency	F <sub>h</sub> : 30 - 82Khz , F <sub>v</sub> : 50 -75Hz
	Audio System	2W speaker x 2	
<b>Input Terminals</b>	1 x VGA (15 Pin Female D-Sub) , 1 x PC Audio (Stereo Headphone Jack) , 1 x DC Power		
<b>Convenient Features</b>	Auto Calibration , Back Light Adjustment , Plug&Play (VESA DDC/CI, DDC 2B)		
	OSD Multi-Languages , Wall Mount Ready (VESA 75 x 75 mm)		
<b>Power</b>	9~36VDC wide voltage input (Isolated DC-DC voltage regulator built-in)		
<b>Power Consumption</b>	Operation / Power	22 watt , < 2 watt (Support DPMS)	
<b>Operating Condition</b>	Temperature / Humidity	0°C ~ 50°C (32°F ~ 122°F) , 10% ~ 90% (no condensation)	
<b>Storage Condition</b>	Temperature / Humidity	- 20°C ~ 60°C (- 4°F ~ 140°F) , 10% ~ 90% (no condensation)	
<b>Certification</b>	FCC , CE		
<b>Dimensions</b>	Physical	W x H x D = 366 x 323 x 61 mm	
		W x H x D = TBD	
	Carton		
<b>Weight</b>	N.W. / G.W.	3.5 Kgs / 4.5 Kgs	
<b>Container Loaded</b>	20ft / 40ft / 40ft HQ	TBD (Sets , By pallet)	

Options	Touch	Video / TV	Enhanced Panel	Others
	Resistive touch	SV + AV	Panel with LED	Digital Signage(Stand
	Capacitive touch	SV + AV + AV	High brightness panel	Networking Digital Signage
	SAW touch	SV + AV + TV	Wide Temperature	Motion Sensor
	Infrared touch		Sunlight Readable	Light Sensor
	Protected glass			Auto-Dimming

## LCD OPTIONS



### Optical Bonding Options

- Optical Bonding provides the best reduction of ambient light washout of any commercially available enhancement technology.
- Optical Bonding has a lower cost than most other competing technologies.
- Optical Bonding offers superior ruggedization, enhancing the display durability under vibration, shock and other environmental extremes.

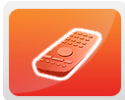

### RS-232 Remote Control Options

**Remote Control Protocol: Command Code to set system**



### 9-36V DC Input Options

iTech offers a selection of DC input from 9V to 36V

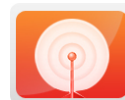

### Light Sensor and Motion Sensor Options

iTech LCD offers Light and Motion Sensor

### Privacy Filter

Front Glass Options:

- Anti Reflective AR Glass 3mm
- Anti Reflective AR Glass 6mm Vandal-Resistance
- Anti Reflective AR Glass 8mm Vandal-Resistance
- Anti Glare AG Glass 3mm



**MECHANICAL DRAWING:**

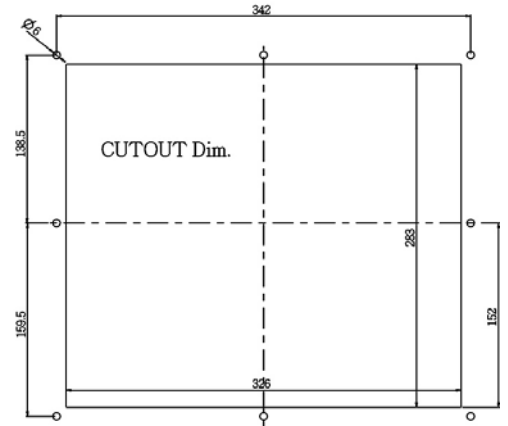
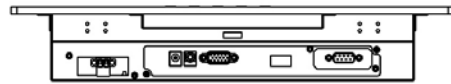
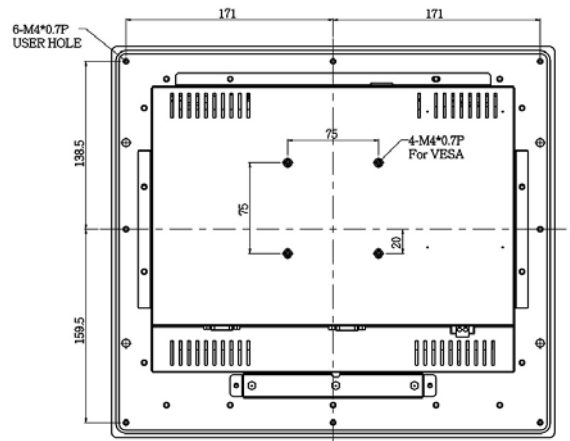
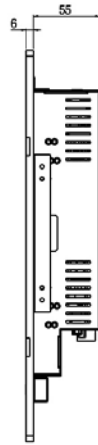
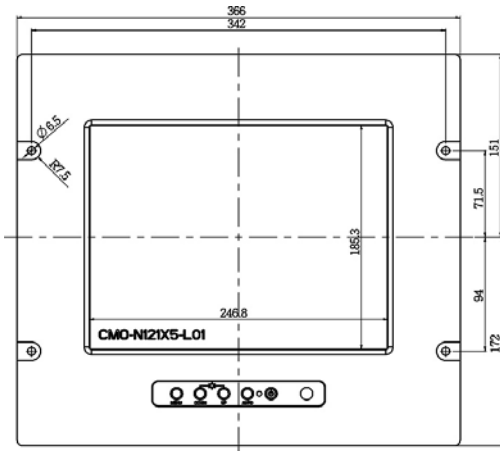

**Option With Stand**

