

Military Grade Rugged IP66 Panel Mount Display



IP66 Military Grade Rugged Panel Mount, 10.1" wide LCD monitor, 1024x600, LED-200 nits, VGA HDMI DVI, AC-IN w/ Built-in Power, Comply MIL-STD-810G Vibration and shock, Power comply MIL-STD-1275D. (Model: EMPMW1010)

Features:

- Modular mechanism design provides flexible product configuration and easy maintenance.
- Optional to built-in touch screen for interactive application.
- Available with auto-brightness sensor offers application in day and night.
- VGA connector with optional AV,SV,AV-Looping
- Complete custom design/solution for OEM customers
- Optional: MIL connector / M12 connector / Plastic IP66 water resistance connector

OPTION MIL

- Environmental: MIL-STD-810, DO-160
- EMI/EMC: MIL-STD-461/462
- Panel construction & lighting: MIL-P-7788
- Power: MIL-STD-704, MIL-STD-1275
- Shock – MIL S 901D
- Vibration – MIL STD 167



Rugged Completely Sealed IP66/NEMA4X Panel Mount LCD Monitor

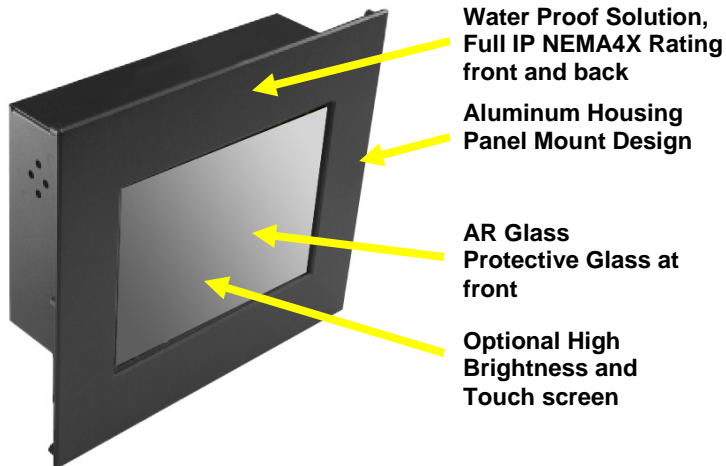

Water Proof Solution,
Full IP NEMA4X Rating
front and back

Aluminum Housing
Panel Mount Design

AR Glass
Protective Glass at
front

Optional High
Brightness and
Touch screen

* IP66 Water and Dust proof
connection for a higher protection



Specification:

Panel	Cell Type / Glass Surface	TFT LCD / Black Anti-Glare, low reflection coating	
	Aspect Ratio / Size	Wide / 10.1" viewable diagonal area	
	Active Area / Pixel Pitch	222.72(H) x 125.28(V) mm / 0.2175(H) x 0.2088(V) mm	
	Native Resolution / Colors	1024(H) x 600(V) / 262 K	
	Brightness / Contrast	200 cd/m ² (typ) / 500 : 1	
	Response Time	< 16 ms	
	Viewing Angle (typical)	H. 90o (- 45o ~ + 45o) , V. 50o(- 30o ~ + 20o)	
	Light Source	LED backlight, Long life, 35,000 hrs (typ)	
Input Sources	PC System	Signal	Analog RGB (0.7/1.0 V _{p-p} , 75 ohms)
		Sync	Separate Sync, Composite Sync, Sync On Green
		Frequency	F _H : 30 - 82Khz , F _V : 50 -75Hz
	Audio System	2W speaker x 2	
Input Terminals	1 x VGA (15 Pin Female D-Sub) , 1 x PC Audio (Stereo Headphone Jack) , 1 x DC Power Plug		
Convenient Features	Auto Calibration , Back Light Adjustment , Plug&Play (VESA DDC/CI, DDC 2B)		
	OSD Multi-Languages , Wall Mount Ready (VESA Dimension - please refer to Drawing)		
Power	12V DC in		
Power Consumption	Operation / Power Saving	8.75 watt , < 1 watt (Support DPMS)	
Operating Condition	Temperature / Humidity	0°C ~ 50°C (32°F ~ 122°F) , 10% ~ 90% (no condensation)	
Storage Condition	Temperature / Humidity	- 20°C ~ 60°C (- 4°F ~ 140°F) , 10% ~ 90% (no condensation)	
Certification		FCC , CE	
Dimensions	Physical	Please refer to Drawing	
	Carton	W x H x D = TBD	
Weight	N.W. / G.W.	3.5 Kgs / 4.5 Kgs	
Container Loaded	20ft / 40ft / 40ft HQ	TBD (Sets , By pallet)	

Options	Touch	Video / TV	Enhanced Panel	Others
	Resistive touch	SV + AV	Panel with LED backlight	Digital Signage(Stand alone)
	Capacitive touch	SV + AV + AV Looping	High brightness panel	Networking Digital Signage
	SAW touch	SV + AV + TV	Wide Temperature	Motion Sensor
	Infrared touch		Sunlight Readable	Light Sensor
	Protected glass			Auto-Dimming

Mechanical Drawing:

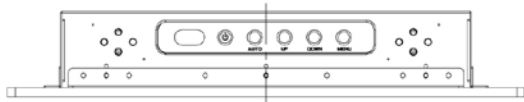
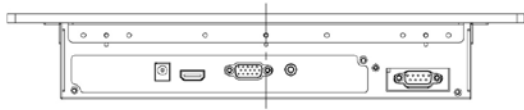
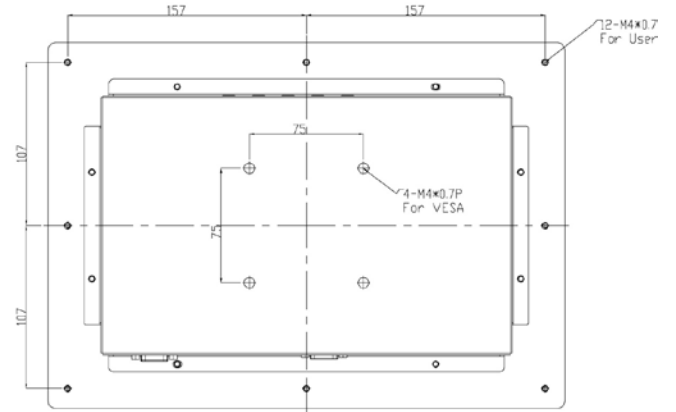
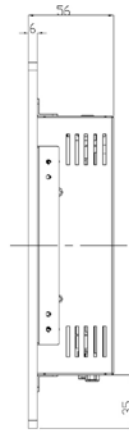
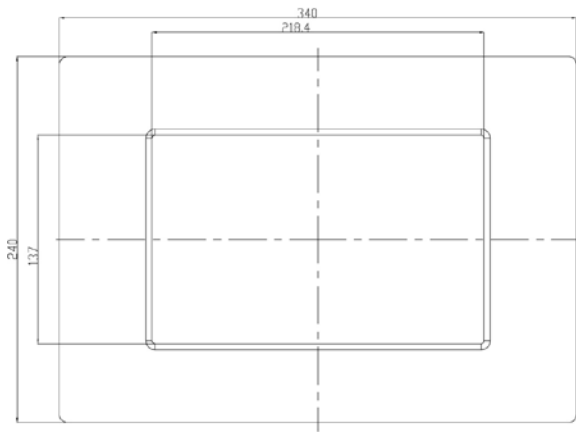

TOP VIEW

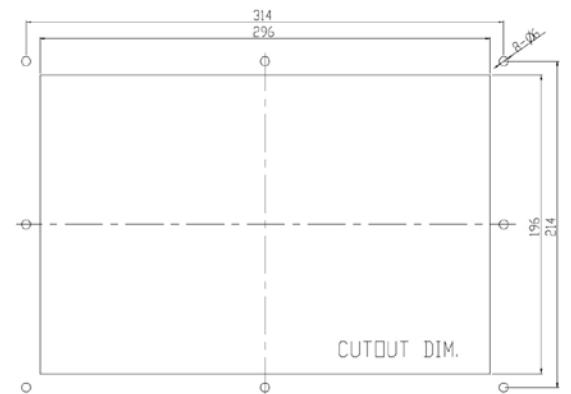

LCD Options:



LED Backlight Options

Introducing LED backlight options for monitors for energy efficiency and a brighter screen.



VIDEO Input Options:

For Video inputs options:

DVI, DVI+HDMI, SVideo+AV, SVideo+AV+DVI, AV+Looping, DVI+AV+Looping, HD-SDI, BNC(PAL/NTSC)



Optical Bonding Options

- Optical Bonding provides the best reduction of ambient light washout of any commercially available enhancement technology.
- Optical Bonding has a lower cost than most other competing technologies.
- Optical Bonding offers superior ruggedization, enhancing the display durability under vibration, shock and other environmental extremes.



RS-232 Remote Control Options

Remote Control Protocol: Command Code to set system



9-36V DC Input Options

iTech offers a selection of DC input from 9V to 36V



Light Sensor and Motion Sensor Options

iTech LCD offers Light and Motion Sensor

Privacy Filter

Front Glass Options:

- Anti Reflective AR Glass 3mm
- Anti Reflective AR Glass 6mm Vandal-Resistance
- Anti Reflective AR Glass 8mm Vandal-Resistance
- Anti Glare AG Glass 3mm