

WIDE TEMPERATURE: Panel Mount Metal Housing LCD Monitor

Industrial 10.4" LCD monitor, 1024x768, LED-400nits VGA, WV(178°/178° MVA), WT(-30° to 70°C), Side OSD including VESA Mount with Capacitive Touch (Finger Only) and USB Controller



- Wide Temp
- High-Brightness 350nits
- Resolution 1024x768
- Wide Viewing Angles
- 50,000 Hrs Long Lifetime

Model: EPM1040XWT-TC

EPM1040WT:

Industrial Panel Mount Metal Housing LCD Monitor (Optional for High Brightness and LED backlight)

FEATURES HIGHLIGHTS:



Metal 5mm Panel Mount for easy installation with stud mount and Clamps mount
(Optional for Front AR Glass or Vandal Resistant glass)

Optional for Resistive/ Capacitive/ SAW/ IR/ Projective Capacitive Touch screen

Auto Video Signal ON / OFF
Auto Always Power On

Optional Stainless steel Bezel 3mm thick



EPMXXXX-WT SERIES
Wide Temperature Range

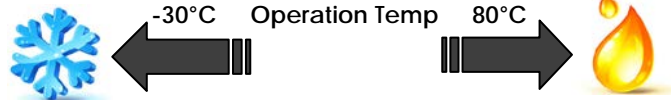

Optional Integrated IP65 Front Panel Mount with water proof sealed Gasket



Side OSD buttons can prevent unnecessary setting changes.

VESA Mounting Hole Pattern

Reliable built-in Power supply for 15" or above
(Optional for 9-36V DC input)



Standard VGA Input
(Optional for DVI, HDMI, AV, BNC, AV looping and SDI)

Optional for RS232 Remote Control Protocol: Command Code to set system

FEATURES:

- Modularize mechanical design provides flexible product configuration and easy maintenance
- Optional build-in touch screen for interactive application
- Available with auto-brightness sensor offers application in day and night
- VGA connector with optional AV.SV.AV-Looping
- Complete custom design/solution for OEM customers

SPECIFICATIONS:

Panel	Cell Type / Glass Surface	TFT LCD / Black Anti-Glare, low reflection coating	
	Aspect Ratio / Size	4 : 3 / 10.4" viewable diagonal area	
	Active Area / Pixel Pitch	210.4(H) x 157.8(V) mm / 0.2055(H) x 0.2055(V) mm	
	Native Resolution / Colors	1024(H) x 768(V) / 16.2 M	
	Brightness / Contrast	400 cd/m ² (typ) / 600 : 1	
	Response Time	≤ 25 ms	
	Viewing Angle (typical)	H. 178o (- 89o ~ + 89o) , V. 178o(- 89o ~ + 89o)	
	Light Source	LED backlight, Long life, 35,000 hrs (typ)	
Input Sources	PC System	Signal	Analog RGB (0.7/1.0 V _{p-p} , 75 ohms)
		Sync	Separate Sync, Composite Sync, Sync On Green
		Frequency	F _h : 30 - 82Khz , F _v : 50 - 75Hz
	Audio System	2W speaker x 2	
Input Terminals	1 x VGA (15 Pin Female D-Sub) , 1 x PC Audio (Stereo Headphone Jack) , 1 x DC Power Plug		
Convenient Features	Auto Calibration , Back Light Adjustment , Plug&Play (VESA DDC/CI, DDC 2B)		
	OSD Multi-Languages , Wall Mount Ready (VESA 75 x 75 mm)		
Power	External AC-to-12VDC power adapter with universal / Auto-Sensing, AC 90 to 260V, 50 / 60 Hz		
Power Consumption	Operation / Power Saving	22 watt , < 2 watt (Support DPMS)	
Operating Condition	Temperature / Humidity	-30°C ~ 70°C (-22°F ~ 158°F) , 10% ~ 90% (no condensation)	
Storage Condition	Temperature / Humidity	-30°C ~ 80°C (-22°F ~ 176°F) , 10% ~ 90% (no condensation)	
Certification	FCC , CE		
Dimensions	Physical	W x H x D = 330 x 265 x 71 mm	
	Carton	W x H x D = TBD	
Weight	N.W. / G.W.	3.5 Kgs / 4.5 Kgs	
Container Loaded	20ft / 40ft / 40ft HQ	TBD (Sets , By pallet)	

Options	Touch	Video/TV	Enhanced Panel	Others
	Resistive touch	SV + AV	Panel with LED backlight	Digital Signage(Stand alone)
	Capacitive touch	SV + AV + AV_Looping	High brightness panel	Networking Digital Signage
	SAW touch	SV + AV + TV	Wide Temperature	Motion Sensor
	Infrared touch		Sunlight Readable	Light Sensor
	Protected glass			Auto-Dimming

MECHANICAL DRAWING:

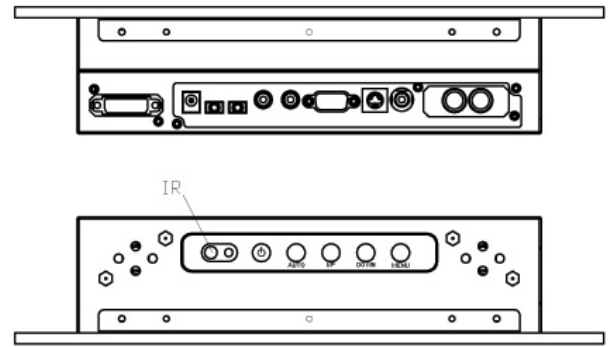
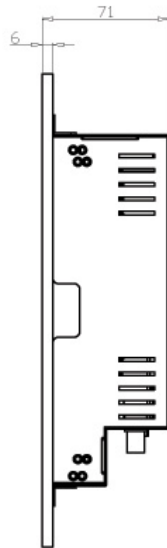
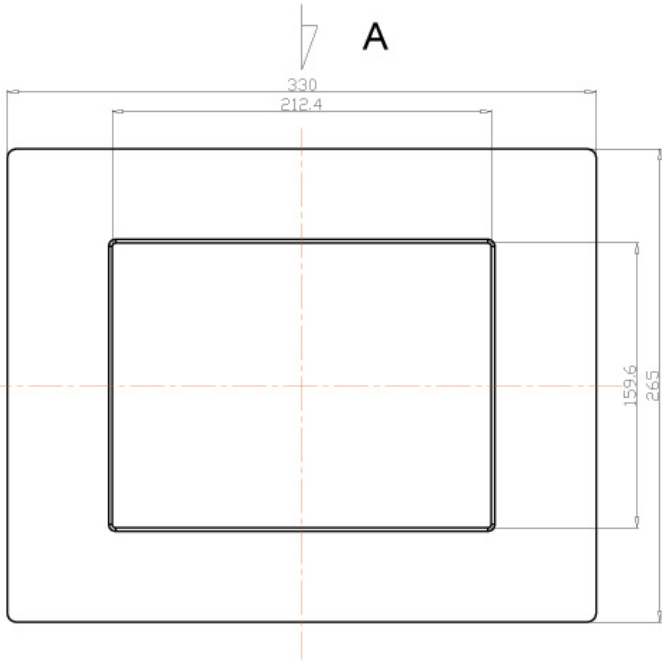

VIEW A

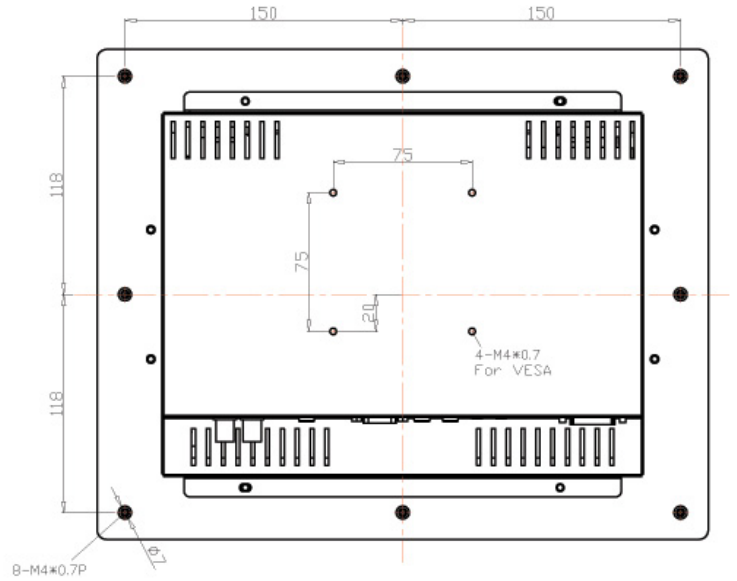
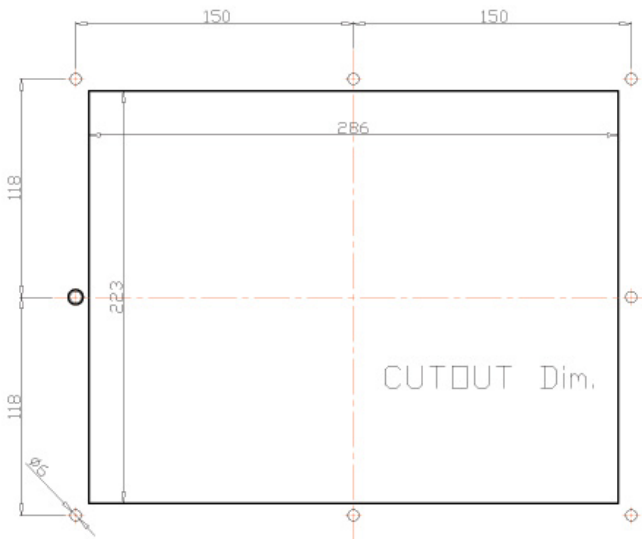

LCD OPTIONS:



LED Backlight Options

Introducing LED backlight options for monitors for energy efficiency and a brighter screen.



TouchScreen Options

Our LCD has a wide selection option to choose which touchscreen technology suits for you.

	Four-Wire Resistive	Five-Wire Resistive	Pen Touch	Capacitive	Surface Wave(Saw)	Infrared Touch (Ir)
PRODUCT SIZE	1.7" - 24"	10.4" - 24"	15" - 19"	12" - 24"	10.4" - 30"	10.4" - 42"
TOUCH LIFE	1 - 2 million touches	30 - 35million touches	100 million touches	100 million touches	50 million touches	Long-term reliability
SCRATCH RESISTANCE	Hard Coated	Hard Coated	Hard Coated (SiO ²)	Hard Coated (SiO ²)	Glass Overlay Moh's hardness rating of 7	Glass Overlay Moh's hardness rating of 7
CONTAMINANT RESISTANCE	Resists moisture, dirt, vinegar, ammonia based food products and cleansers	Resists moisture, dirt, vinegar, ammonia based food products and cleansers	Resists moisture, dirt, vinegar, ammonia based food products and cleansers	Resists moisture, dirt, vinegar, ammonia based food products and cleansers	Resists moisture, dirt, vinegar, ammonia based food products and cleansers	Resists moisture, dirt, vinegar, ammonia based food products and cleansers
INPUT METHOD	Finger, Gloved Hand, Stylus	Finger, Gloved Hand, Stylus	Stylus Pen	Finger	Finger, Gloved Hand, Soft pliable stylus	Finger, Gloved Hand, Stylus
CONTROLLER	USB, RS232	USB, RS232	USB, RS232	USB, RS232	USB, RS232	USB, RS232



VIDEO Input Options:

For Video inputs options:

DVI, DVI+HDMI, SVideo+AV, SVideo+AV+DVI, AV+Looping, DVI+AV+Looping, HD-SDI, BNC(PAL/NTSC)

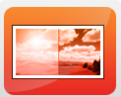

Optical Bonding Options

- Optical Bonding provides the best reduction of ambient light washout of any commercially available enhancement technology.
- Optical Bonding has a lower cost than most other competing technologies.
- Optical Bonding offers superior ruggedization, enhancing the display durability under vibration, shock and other environmental extremes.

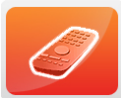

RS-232 Remote Control Options

Remote Control Protocol: Command Code to set system



9-36V DC Input Options

iTech offers a selection of DC input from 9V to 36V

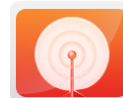

Light Sensor and Motion Sensor Options

iTech LCD offers Light and Motion Sensor

Privacy Filter

Front Glass Options:

- Anti Reflective AR Glass 3mm
- Anti Reflective AR Glass 6mm Vandal-Resistance
- Anti Reflective AR Glass 8mm Vandal-Resistance
- Anti Glare AG Glass 3mm