

Industrial LCD Display



High Brightness

16:9 Ratio

4:3 Ratio



Table of Contents

I. Table of Contents	Page. 1
II. Aspect Ratio 4:3 TFT LCD Display	
6.4" Industrial Grade TFT LCD Display	Page. 2
10.4" Industrial Grade TFT LCD Display	Page. 3
12.1" Industrial Grade TFT LCD Display	Page. 4
15" Industrial Grade TFT LCD Display	Page. 5
17" Industrial Grade TFT LCD Display	Page. 6
19" Industrial Grade TFT LCD Display	Page. 7
III. Aspect Ratio 16:9 Wide Screen	
17" Industrial Grade Wide Screen LCD Display	Page. 8
26" Industrial Grade Wide Screen LCD Display	Page. 9
32" Industrial Grade Wide Screen LCD Display	Page. 10
40" Industrial Grade Wide Screen LCD Display	Page. 11
IV. High Brightness LCD Display	
15" High Brightness LCD Display	Page. 12
17" High Brightness LCD Display	Page. 13
19" High Brightness LCD Display	Page. 14



Features

- 300cd/m² industrial brightness
- 6.4" VGA TFT LCD support 640 x 480 pixels
- OSD control keys to optimize the display
- Different models fit for various applications

Options



iAP600



6mm Aluminum Front

- Rugged construction
- 6mm Aluminum front cover
- Optional front IP protection

iDP600



Stylish Aluminum Front

- Stylish Aluminum front cover
- Slim and light weight design
- Various mounting for different applications

iOP600



Flexible Open Frame

- Front mounting for flexibility integration
- Compact and light weight design
- Various options for OEM applications

Dimensions

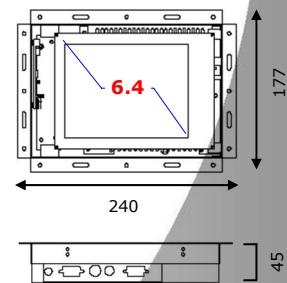
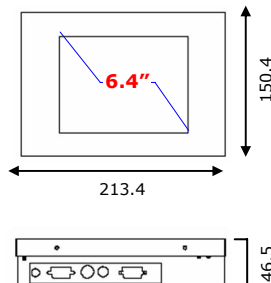
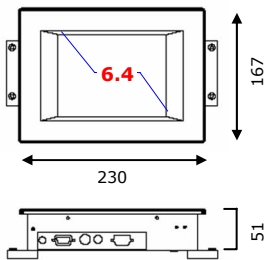

Unit: mm

Specifications

LCD Type	6.4 inch Grade A industrial TFT LCD Panel
Resolution	640 x 480, VGA
Display Color	262,144 color
Brightness	300 cd/m ²
Contrast Ratio	180 : 1 (Typical)
Viewing Angle	55 / 55 / 15 / 35 (L / R / U / D)
VGA Connector	D-Sub 15 pin VGA analog
Power Supply	External DC Power Adapter
LCD MTBF.	20,000 hrs
Operating Temp.	-20 to 70°C
Storage Temp.	-30 to 70°C
Humidity	95%, non condensing
Shock	10G peak acceleration (11ms)
Safety Approval	CE, FCC

Ordering information

Model	Description
iAP600	6.4" 6mm Aluminum front industrial grade TFT LCD display panel
iDP600	6.4" 1.2mm Aluminum front industrial grade TFT LCD display panel
iOP600	6.4" Open Frame industrial grade TFT LCD display panel

Package information

Model	iAP600	iDP600	iOP600
Carton Box	480 x 362 x 85mm		
Net Weight	1.5 kg	1 kg	1 kg
Gross Weight	3.5 kg	3 kg	3 kg



Features

- 350cd/m² industrial brightness
- 10.4" SVGA TFT LCD support 800 x 600 pixels
- OSD control keys to optimize the display
- Different models fit for various applications

Options



iAP1000



6mm Aluminum Front

- Rugged construction
- 6mm Aluminum front cover
- Optional front IP protection

iDP1000



Stylish Aluminum Front

- Stylish Aluminum front cover
- Slim and light weight design
- Various mounting for different applications

iOP1000



Flexible Open Frame

- Front mounting for flexibility integration
- Compact and light weight design
- Various options for OEM applications

Dimensions

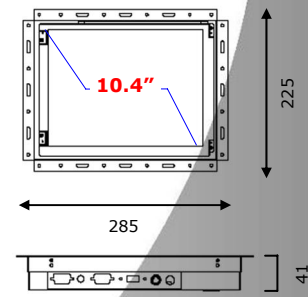
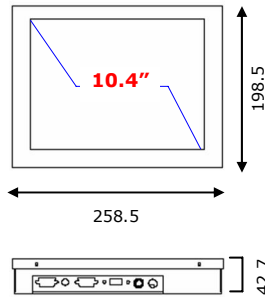
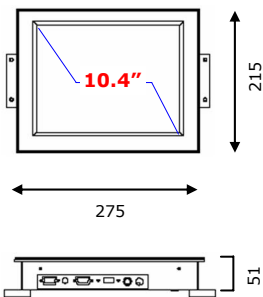

Unit: mm

Specifications

LCD Type	10.4 inch Grade A industrial TFT LCD Panel
Resolution	800 x 600, SVGA
Display Color	262,144 color
Brightness	350 cd/m ²
Contrast Ratio	180 : 1 (Typical)
Viewing Angle	60 / 60 / 55 / 40 (L / R / U / D)
VGA Connector	D-Sub 15 pin VGA analog
Power Supply	External DC Power Adapter
LCD MTBF.	50,000 hrs
Operating Temp.	0 to 50°C
Storage Temp.	-20 to 60°C
Humidity	80%, non condensing
Vibration	10 to 58Hz, ±0.15mm; 58 to 500Hz, 1g
Safety Approval	CE, FCC

Ordering information

Model	Description
iAP1000	10.4" 6mm Aluminum front industrial grade TFT LCD display panel
iDP1000	10.4" 1.2mm Aluminum front industrial grade TFT LCD display panel
iOP1000	10.4" Open Frame industrial grade TFT LCD display panel

Package information

Model	iAP1000	iDP1000	iOP1000
Carton Box	480 x 362 x 85mm		
Net Weight	2.5 kg	2 kg	2 kg
Gross Weight	4.5 kg	4 kg	4 kg



Features

- LG 12.1" SVGA TFT LCD
- 300cd/m² industrial brightness
- Support 800 x 600 pixels
- OSD control keys to optimize the display

Options



iAP1200



iDP1200



iOP1200

6mm Aluminum Front

- Rugged construction
- 6mm Aluminum front cover
- Optional front IP protection

Stylish Aluminum Front

- Stylish Aluminum front cover
- Slim and light weight design
- Various mounting for different applications

Flexible Open Frame

- Front mounting for flexibility integration
- Compact and light weight design
- Various options for OEM applications

Dimensions

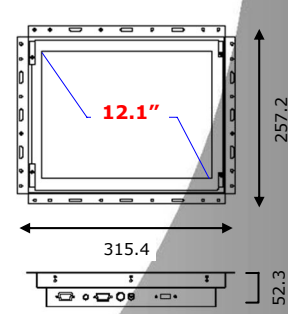
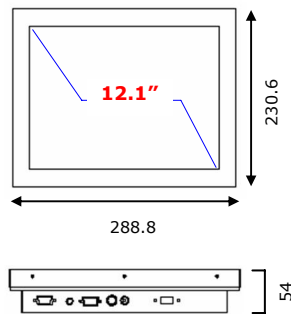
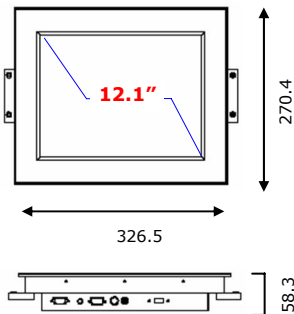

Unit: mm

Specifications

LCD Manufacturer



LCD Type	LG 12.1 inch Grade A industrial TFT LCD Panel
Resolution	800 x 600, SVGA
Display Color	262,144 color
Brightness	300 cd/m ²
Contrast Ratio	200 : 1 (Typical)
Viewing Angle	60 / 60 / 40 / 55 (L / R / U / D)
VGA Connector	D-Sub 15 pin VGA analog
Power Supply	External DC Power Adapter
LCD MTBF.	50,000 hrs
Operating Temp.	0 to 50°C
Storage Temp.	-20 to 60°C
Humidity	90%, non condensing
Vibration	10 to 58Hz, ±0.15mm; 58 to 500Hz, 1g
Safety Approval	CE, FCC

Ordering information

Model	Description
iAP1200	12.1" 6mm Aluminum front industrial grade TFT LCD display panel
iDP1200	12.1" 1.2mm Aluminum front industrial grade TFT LCD display panel
iOP1200	12.1" Open Frame industrial grade TFT LCD display panel

Package information

Model	iAP1200	iDP1200	iOP1200
Carton Box	555 x 470 x 90mm		
Net Weight	2.5 kg	2 kg	2 kg
Gross Weight	4.5 kg	4 kg	4 kg



Features

- **SAMSUNG** Samsung 15" XGA TFT LCD
- 450cd/m² industrial brightness
- Support 1024 x 768 pixels
- OSD control keys to optimize the display

Options



iAP1500

6mm Aluminum Front

- Rugged construction
- 6mm Aluminum front cover
- Optional front IP protection



iDP1500

Stylish Aluminum Front

- Stylish Aluminum front cover
- Slim and light weight design
- Various mounting for different applications



iOP1500

Flexible Open Frame

- Front mounting for flexibility integration
- Compact and light weight design
- Various options for OEM applications

Dimensions

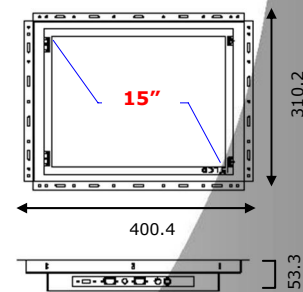
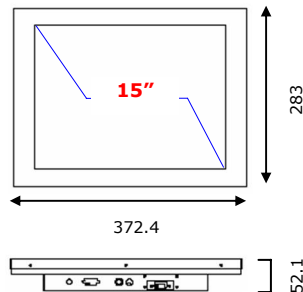
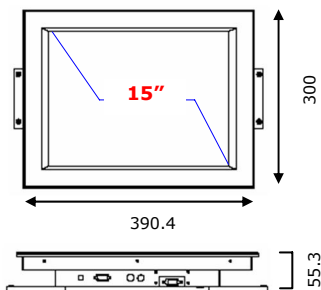

Unit: mm

Specifications

LCD Manufacturer



LCD Type	Samsung 15 inch Grade A industrial TFT LCD Panel
Resolution	1024 x 768, XGA
Display Color	16,194,277 color
Brightness	450 cd/m ²
Contrast Ratio	300 : 1 (Typical)
Viewing Angle	70 / 70 / 60 / 65 (L / R / U / D)
VGA Connector	D-Sub 15 pin VGA analog
Power Supply	External DC Power Adapter
LCD MTBF.	50,000 hrs
Operating Temp.	0 to 50°C
Storage Temp.	-20 to 60°C
Humidity	70%, non condensing
Vibration	10 to 58Hz, ±0.15mm; 58 to 500Hz, 1g
Safety Approval	CE, FCC

Ordering information

Model	Description
iAP1500	15" 6mm Aluminum front industrial grade TFT LCD display panel
iDP1500	15" 1.2mm Aluminum front industrial grade TFT LCD display panel
iOP1500	15" Open Frame industrial grade TFT LCD display panel

Package information

Model	iAP1500	iDP1500	iOP1500
Carton Box	555 x 470 x 90mm		
Net Weight	3.5 kg	3 kg	2.5 kg
Gross Weight	5.5 kg	5 kg	4.5 kg



Features

- **SAMSUNG** Samsung 17" SXGA TFT LCD
- 300cd/m² industrial brightness
- Support 1280 x 1024 pixels
- OSD control keys to optimize the display

Options



iAP1700

6mm Aluminum Front

- Rugged construction
- 6mm Aluminum front cover
- Optional front IP protection



iDP1700

Stylish Aluminum Front

- Stylish Aluminum front cover
- Slim and light weight design
- Various mounting for different applications



iOP1700

Flexible Open Frame

- Front mounting for flexibility integration
- Compact and light weight design
- Various options for OEM applications

Dimensions

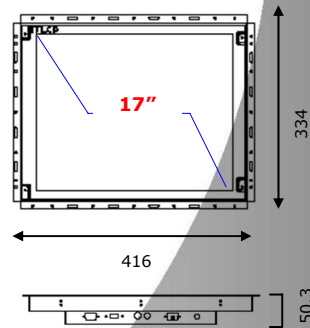
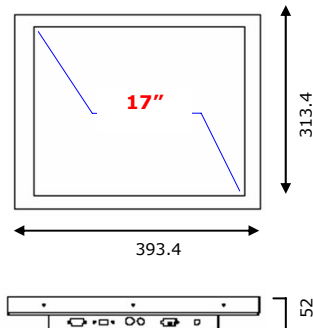
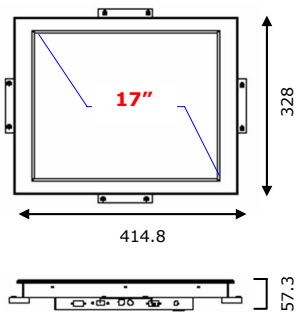

Unit: mm

Specifications

LCD Manufacturer



LCD Type	Samsung 17 inch Grade A industrial TFT LCD Panel
Resolution	1280 x 1024, SXGA
Display Color	16,194,277 color
Brightness	300 cd/m ²
Contrast Ratio	500 : 1 (Typical)
Viewing Angle	75 / 75 / 75 / 60 (L / R / U / D)
VGA Connector	D-Sub 15 pin VGA analog
Power Supply	External DC Power Adapter
LCD MTBF.	50,000 hrs
Operating Temp.	0 to 50°C
Storage Temp.	-25 to 60°C
Humidity	90%, non condensing
Vibration	10 to 58Hz, ±0.15mm; 58 to 500Hz, 1g
Safety Approval	CE, FCC

Ordering information

Model	Description
iAP1700	17" 6mm Aluminum front industrial grade TFT LCD display panel
iDP1700	17" 1.2mm Aluminum front industrial grade TFT LCD display panel
iOP1700	17" Open Frame industrial grade TFT LCD display panel

Package information

Model	iAP1700	iDP1700	iOP1700
Carton Box	630 x 550 x 110mm		
Net Weight	5.5 kg	5 kg	4.5 kg
Gross Weight	7.5 kg	7 kg	6.5 kg



Features

- **SAMSUNG** Samsung 19" SXGA TFT LCD
- 250cd/m² industrial brightness
- Support 1280 x 1024 pixels
- OSD control keys to optimize the display

Options



iAP1900

6mm Aluminum Front

- Rugged construction
- 6mm Aluminum front cover
- Optional front IP protection



iDP1900

Stylish Aluminum Front

- Stylish Aluminum front cover
- Slim and light weight design
- Various mounting for different applications



iOP1900

Flexible Open Frame

- Front mounting for flexibility integration
- Compact and light weight design
- Various options for OEM applications

Dimensions

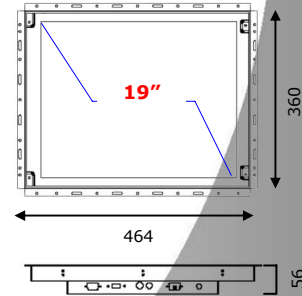
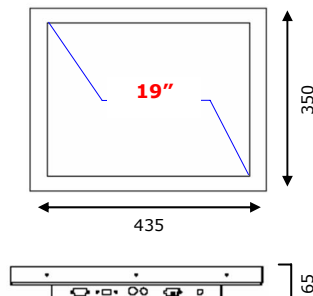
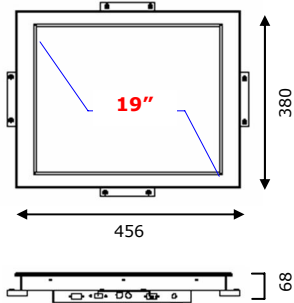

Unit: mm

Specifications

LCD Manufacturer



LCD Type	Samsung 19 inch Grade A industrial TFT LCD Panel
Resolution	1280 x 1024, SXGA
Display Color	16,194,277 color
Brightness	250 cd/m ²
Contrast Ratio	700 : 1 (Typical)
Viewing Angle	89 / 89 / 89 / 89 (L / R / U / D)
VGA Connector	D-Sub 15 pin VGA analog
Power Supply	External DC Power Adapter
LCD MTBF.	50,000 hrs
Operating Temp.	0 to 50°C
Storage Temp.	-25 to 65°C
Humidity	90%, non condensing
Vibration	10 to 58Hz, ±0.15mm; 58 to 500Hz, 1g
Safety Approval	CE, FCC

Ordering information

Model	Description
iAP1900	19" 6mm Aluminum front industrial grade TFT LCD display panel
iDP1900	19" 1.2mm Aluminum front industrial grade TFT LCD display panel
iOP1900	19" Open Frame industrial grade TFT LCD display panel

Package information

Model	iAP1900	iDP1900	iOP1900
Carton Box	630 x 550 x 110mm		
Net Weight	6.5 kg	6 kg	5.5 kg
Gross Weight	8.5 kg	8 kg	7.5 kg



Features

- **SAMSUNG** Samsung 16:9 wide screen LCD panel
- 17" WXGA high resolution with 1280 x 768 pixels
- OSD control keys to optimize the display
- Different models fit for various applications

Options



iAP1700W



6mm Aluminum Front

- Rugged construction
- 6mm Aluminum front cover
- Optional front IP protection

iDP1700W

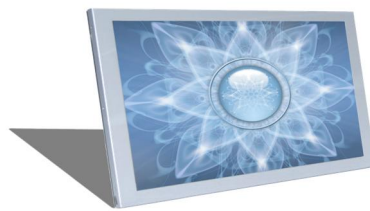

Stylish Aluminum Front

- Stylish Aluminum front cover
- Slim and light weight design
- Various mounting for different applications

iOP1700W



Flexible Open Frame

- Front mounting for flexibility integration
- Compact and light weight design
- Various options for OEM applications

Dimensions

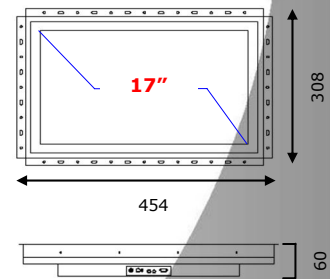
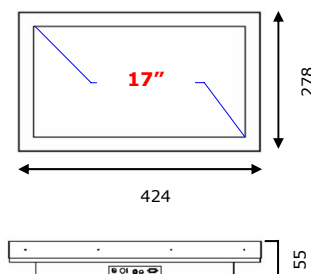
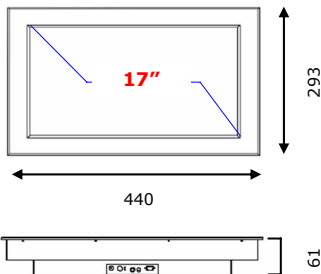

Unit: mm

Specifications

LCD Manufacturer



LCD Type	Samsung 17 inch Grade A industrial TFT LCD Panel
Resolution	1280 x 768, WXGA
Display Color	16,194,277 color
Brightness	450 cd/m ²
Contrast Ratio	400 : 1 (Typical)
Viewing Angle	70 / 70 / 50 / 60 (L / R / U / D)
VGA Connector	D-Sub 15 pin VGA analog
Power Supply	External DC Power Adapter
LCD MTBF.	50,000 hrs
Operating Temp.	0 to 50°C
Storage Temp.	-20 to 60°C
Humidity	95%, non condensing
Vibration	10 to 58Hz, ±0.15mm; 58 to 500Hz, 1g
Safety Approval	CE, FCC

Ordering information

Model	Description
iAP1700W	17" 6mm Aluminum front industrial grade TFT LCD display panel
IDP1700W	17" 1.2mm Aluminum front industrial grade TFT LCD display panel
IOP1700W	17" Open Frame industrial grade TFT LCD display panel

Package information

Model	iAP1700W	IDP1700W	IOP1700W
Carton Box	570 x 425 x 160mm	508 x 536 x 183mm	
Net Weight	4.94 kg	4.94 kg	4.94 kg
Gross Weight	10 kg	10 kg	10 kg



Features

- **SAMSUNG** Samsung 16:9 wide screen LCD panel
- 26" WXGA high resolution with 1366 x 768 pixels
- OSD control keys to optimize the display
- Different models fit for various applications

Options



iAP2600W



6mm Aluminum Front

- Rugged construction
- 6mm Aluminum front cover
- Optional front IP protection

iDP2600W

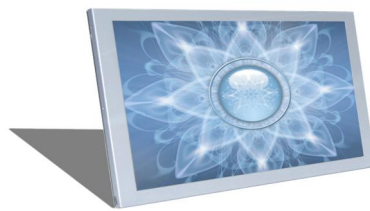

Stylish Aluminum Front

- Stylish Aluminum front cover
- Slim and light weight design
- Various mounting for different applications

iOP2600W



Flexible Open Frame

- Front mounting for flexibility integration
- Compact and light weight design
- Various options for OEM applications

Dimensions

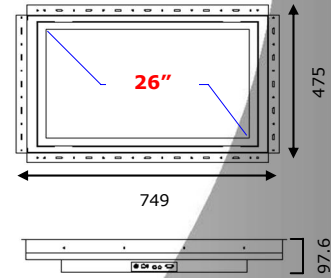
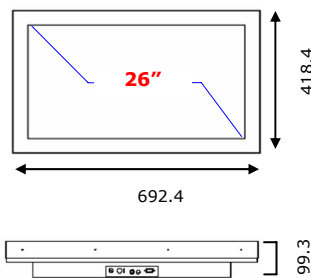
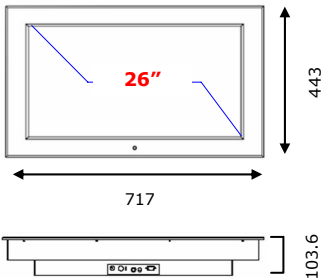

Unit: mm

Specifications

LCD Manufacturer



LCD Type	Samsung 26 inch Grade A industrial TFT LCD Panel
Resolution	1366 x 768, WXGA
Display Color	16.7M color
Brightness	500 cd/m ²
Contrast Ratio	1000 : 1 (Typical)
Viewing Angle	85 / 85 / 85 / 85 (L / R / U / D)
VGA Connector	D-Sub 15 pin VGA analog
Power Supply	External DC Power Adapter
LCD MTBF.	50,000 hrs
Operating Temp.	0 to 50°C
Storage Temp.	-20 to 65°C
Humidity	90%, non condensing
Vibration	10 to 58Hz, ±0.15mm; 58 to 500Hz, 1g
Safety Approval	CE, FCC

Ordering information

Model	Description
iAP2600W	26" 6mm Aluminum front industrial grade TFT LCD display panel
IDP2600W	26" 1.2mm Aluminum front industrial grade TFT LCD display panel
IOP2600W	26" Open Frame industrial grade TFT LCD display panel

Package information

Model	iAP2600W	IDP2600W	IOP2600W
Carton Box	876 x 714 x 338mm		
Net Weight	15.01 kg	15.01 kg	15.01 kg
Gross Weight	25 kg	25 kg	25 kg



Features

- **SAMSUNG** Samsung 16:9 wide screen LCD panel
- 32" WXGA high resolution with 1366 x 768 pixels
- OSD control keys to optimize the display
- Different models fit for various applications

Options



iAP3200W



6mm Aluminum Front

- Rugged construction
- 6mm Aluminum front cover
- Optional front IP protection

iDP3200W



Stylish Aluminum Front

- Stylish Aluminum front cover
- Slim and light weight design
- Various mounting for different applications

iOP3200W



Flexible Open Frame

- Front mounting for flexibility integration
- Compact and light weight design
- Various options for OEM applications

Dimensions

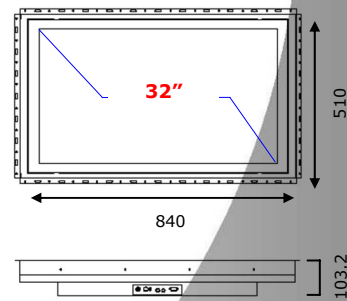
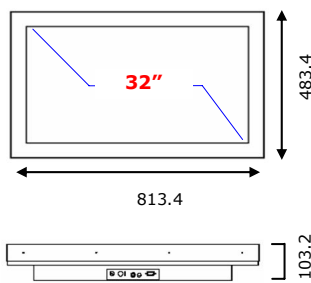
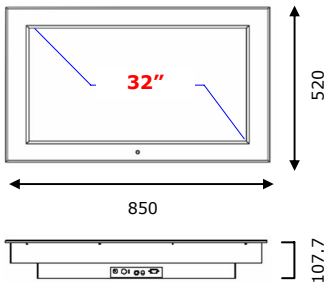

Unit: mm

Specifications

LCD Manufacturer



LCD Type	Samsung 32 inch Grade A industrial TFT LCD Panel
Resolution	1366 x 768, WXGA
Display Color	16.7M color
Brightness	450 cd/m ²
Contrast Ratio	1000 : 1 (Typical)
Viewing Angle	85 / 85 / 85 / 85 (L / R / U / D)
VGA Connector	D-Sub 15 pin VGA analog
Power Supply	External DC Power Adapter
LCD MTBF.	50,000 hrs
Operating Temp.	0 to 50°C
Storage Temp.	-20 to 60°C
Humidity	90%, non condensing
Vibration	10 to 58Hz, ±0.15mm; 58 to 500Hz, 1g
Safety Approval	CE, FCC

Ordering information

Model	Description
iAP3200W	32" 6mm Aluminum front industrial grade TFT LCD display panel
IDP3200W	32" 1.2mm Aluminum front industrial grade TFT LCD display panel
IOP3200W	32" Open Frame industrial grade TFT LCD display panel

Package information

Model	iAP3200W	iDP3200W	iOP3200W
Carton Box	900 x 620 x 380mm		
Net Weight	22.98 kg	22.981 kg	22.98 kg
Gross Weight	39 kg	39 kg	39 kg



Features

- **SAMSUNG** Samsung 16:9 wide screen LCD panel
- 40" WXGA high resolution with 1366 x 768 pixels
- OSD control keys to optimize the display
- Different models fit for various applications

Options



iAP4000W



6mm Aluminum Front

- Rugged construction
- 6mm Aluminum front cover
- Optional front IP protection

iDP4000W



Stylish Aluminum Front

- Stylish Aluminum front cover
- Slim and light weight design
- Various mounting for different applications

iOP4000W



Flexible Open Frame

- Front mounting for flexibility integration
- Compact and light weight design
- Various options for OEM applications

Dimensions

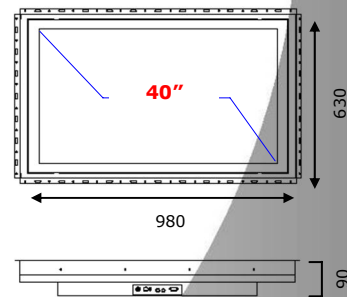
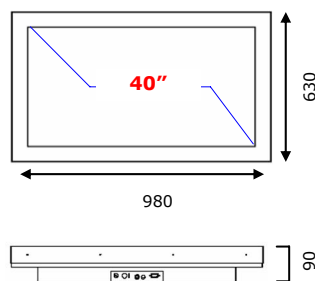
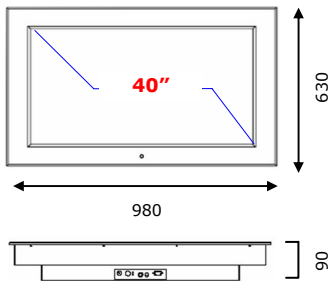

Unit: mm

Specifications

LCD Manufacturer



LCD Type	Samsung 40 inch Grade A industrial TFT LCD Panel
Resolution	1366 x 768, WXGA
Display Color	16.7M color
Brightness	500 cd/m ²
Contrast Ratio	800 : 1 (Typical)
Viewing Angle	85 / 85 / 85 / 85 (L / R / U / D)
VGA Connector	D-Sub 15 pin VGA analog
Power Supply	External DC Power Adapter
LCD MTBF.	50,000 hrs
Operating Temp.	0 to 50°C
Storage Temp.	-20 to 60°C
Humidity	93.8%, non condensing
Vibration	10 to 58Hz, ±0.15mm; 58 to 500Hz, 1g
Safety Approval	CE, FCC

Ordering information

<u>Model</u>	<u>Description</u>
iAP4000W	40" 6mm Aluminum front industrial grade TFT LCD display panel
iDP4000W	40" 1.2mm Aluminum front industrial grade TFT LCD display panel
iOP4000W	40" Open Frame industrial grade TFT LCD display panel

Package information

Model	iAP4000W	iDP4000W	iOP4000W
Carton Box	1021 x 851 x 330mm		
Net Weight	44.98 kg	44.98 kg	44.98 kg
Gross Weight	60 kg	60 kg	60 kg



Features

- **SAMSUNG** Samsung 15" XGA TFT LCD
- SunRead Ultra high Brightness LCD Panel
- 1400 cd/m² Outdoor Brightness
- High resolution with 1024 x 768 pixels
- Different models fit for various applications

Options



iHAP1500

6mm Aluminum Front

- Rugged construction
- 6mm Aluminum front cover
- Optional front IP protection



iHDP1500

Stylish Aluminum Front

- Stylish Aluminum front cover
- Slim and light weight design
- Various mounting for different applications



iHOP1500

Flexible Open Frame

- Front mounting for flexibility integration
- Compact and light weight design
- Various options for OEM applications

Dimensions

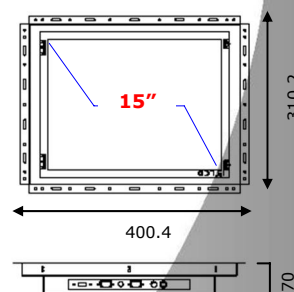
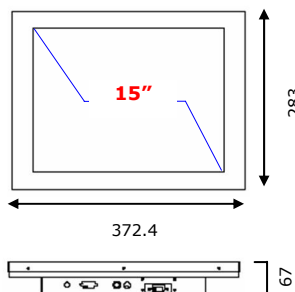
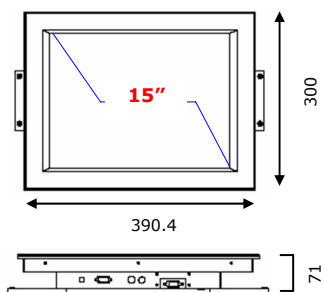

Unit: mm

Specifications

LCD Manufacturer



LCD Type	Samsung 15 inch Grade A industrial TFT LCD Panel
Resolution	1024 x 768, XGA
Display Color	16,194,277 color
Brightness	1400 cd/m ²
Contrast Ratio	300 : 1 (Typical)
Viewing Angle	70 / 70 / 60 / 65 (L / R / U / D)
VGA Connector	D-Sub 15 pin VGA analog
Power Supply	External DC Power Adapter
LCD MTBF.	50,000 hrs
Operating Temp.	0 to 50°C
Storage Temp.	-20 to 60°C
Humidity	70%, non condensing
Vibration	10 to 58Hz, ±0.15mm; 58 to 500Hz, 1g
Safety Approval	CE, FCC

Ordering information

<u>Model</u>	<u>Description</u>
iHAP1500	15" 6mm Aluminum front industrial grade TFT LCD display panel
iHDP1500	15" 1.2mm Aluminum front industrial grade TFT LCD display panel
iHOP1500	15" Open Frame industrial grade TFT LCD display panel

Package information

Model	iHAP1500	iHDP1500	iHOP1500
Carton Box	555 x 470 x 90mm		
Net Weight	3.5 kg	3 kg	2.5 kg
Gross Weight	5.5 kg	5 kg	4.5 kg

15" LCD Display High Brightness



Features

- **SAMSUNG** Samsung 17" SXGA TFT LCD
- SunRead Ultra high Brightness LCD Panel
- 1000 cd/m² Outdoor Brightness
- High resolution with 1280 x 1024 pixels
- Different models fit for various applications

Options



iHAP1700

6mm Aluminum Front

- Rugged construction
- 6mm Aluminum front cover
- Optional front IP protection



iHDP1700

Stylish Aluminum Front

- Stylish Aluminum front cover
- Slim and light weight design
- Various mounting for different applications



iHOP1700

Flexible Open Frame

- Front mounting for flexibility integration
- Compact and light weight design
- Various options for OEM applications

Dimensions

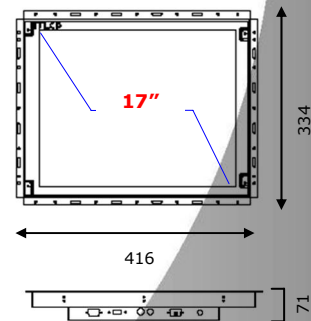
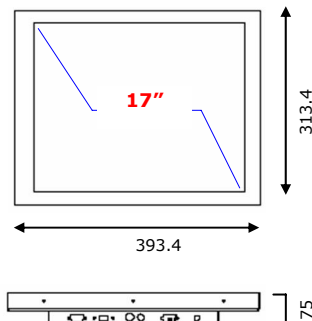
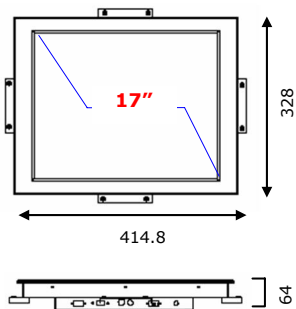

Unit: mm

Specifications

LCD Manufacturer	SAMSUNG
LCD Type	Samsung 17 inch Grade A industrial TFT LCD Panel
Resolution	1280 x 1024, SXGA
Display Color	16,194,277 color
Brightness	1000 cd/m ²
Contrast Ratio	350 : 1 (Typical)
Viewing Angle	75 / 75 / 75 / 60 (L / R / U / D)
VGA Connector	D-Sub 15 pin VGA analog
Power Supply	External DC Power Adapter
LCD MTBF.	50,000 hrs
Operating Temp.	0 to 50°C
Storage Temp.	-25 to 60°C
Humidity	90%, non condensing
Vibration	10 to 58Hz, ±0.15mm; 58 to 500Hz, 1g
Safety Approval	CE, FCC

Ordering information

<u>Model</u>	<u>Description</u>
iHAP1700	17" 6mm Aluminum front industrial grade TFT LCD display panel
iHDP1700	17" 1.2mm Aluminum front industrial grade TFT LCD display panel
iHOP1700	17" Open Frame industrial grade TFT LCD display panel

Package information

Model	iHAP1700	iHDP1700	iHOP1700
Carton Box	630 x 550 x 110mm		
Net Weight	5.5 kg	5 kg	4.5 kg
Gross Weight	7.5 kg	7 kg	6.5 kg



Features

- **SAMSUNG** Samsung 19" SXGA TFT LCD
- SunRead Ultra high Brightness LCD Panel
- 1000 cd/m² Outdoor Brightness
- High resolution with 1280 x 1024 pixels
- Different models fit for various applications

Options



iHAP1900

6mm Aluminum Front

- Rugged construction
- 6mm Aluminum front cover
- Optional front IP protection



iHDP1900

Stylish Aluminum Front

- Stylish Aluminum front cover
- Slim and light weight design
- Various mounting for different applications



iHOP1900

Flexible Open Frame

- Front mounting for flexibility integration
- Compact and light weight design
- Various options for OEM applications

Dimensions

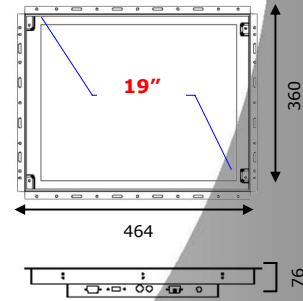
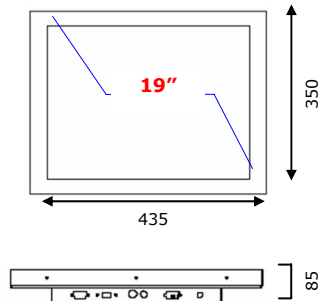
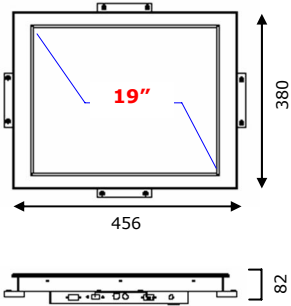

Unit: mm

Specifications

LCD Manufacturer



LCD Type	Samsung 19 inch Grade A industrial TFT LCD Panel
Resolution	1280 x 1024, SXGA
Display Color	16,194,277 color
Brightness	1000 cd/m ²
Contrast Ratio	350 : 1 (Typical)
Viewing Angle	89 / 89 / 89 / 89 (L / R / U / D)
VGA Connector	D-Sub 15 pin VGA analog
Power Supply	External DC Power Adapter
LCD MTBF.	50,000 hrs
Operating Temp.	0 to 50°C
Storage Temp.	-25 to 65°C
Humidity	90%, non condensing
Vibration	10 to 58Hz, ±0.15mm; 58 to 500Hz, 1g
Safety Approval	CE, FCC

Ordering information

<u>Model</u>	<u>Description</u>
iHAP1900	19" 6mm Aluminum front industrial grade TFT LCD display panel
iHDP1900	19" 1.2mm Aluminum front industrial grade TFT LCD display panel
iHOP1900	19" Open Frame industrial grade TFT LCD display panel

Package information

Model	iHAP1900	iHDP1900	iHOP1900
Carton Box	630 x 550 x 110mm		
Net Weight	6.5 kg	6 kg	5.5 kg
Gross Weight	8.5 kg	8 kg	7.5 kg