

# User Manual

RK-401 / 801 / 1601

1U Rackmount Keyboard Drawer  
with PS/2 KVM Switch

# 1. Table Of Content

<b>1. Table of Content</b>	P.1
<b>2. Introduction</b>	P.2
<b>3. Features</b>	P.2
<b>4. Package Content</b>	P.3
<b>5. Optional Accessories</b>	P.4
<b>6. Peripheral Products</b>	P.4
<b>7. Important Safeguards</b>	P.5
<b>8. Structure Diagram</b>	P.6
<b>9. Dimension Diagram</b>	P.7
<b>10. Keyboard Layout</b>	P.8
<b>11. KVM Session</b>	
Front View	P.9
Rear View	P.10
Installation Steps	P.11
Cascading	P.12
<b>12. Start Up</b>	P.13
HotKey Command	P.13
HotKey Command Operation	P.14-15
KVM On Screen Display Control	
OSD Structure Diagram	P.16
OSD Menu Operation	P.16-17
<b>13. FAQ</b>	P.18
<b>14. Technical Specification</b>	P.19

## 2. Introduction

RK Series is a combination of keyboard and mouse with PS/2 KVM switch into a drawer, with features such as adjustable brackets, built in KVM OSD controls to provide effective assistant for an administrator to control multiple PCs.

RK Series provides cost effective for your limited IT budget over using a full set of keyboard and mouse and rack mounting. Also, it will be space saving for your compact environment rack and effective assistant for an administrator to control multiple PCs.

## 3. Features

- Rugged metal Construction
- Standard 19", 1U height rackmount keyboard drawer
- Adjustable mounting brackets from 390 to 740mm (front to rear 19" mounts)
- Lockable drawer to secure the keyboard and mouse
- Slide rails have two fixed positions to prevent movement of the keyboard
- Three keyboard selections supporting multiple languages
- Built-in KVM switch function for easy controlling and monitoring up to 16 residing servers / platforms
- Support eight characters password protection and search PC server name
- Auto scan mode for monitoring PCs and flexible scan time from 5 ~ 99 seconds
- Hot Pluggable—Add or remove computers without powering down the switch
- Easily switch individual button to select the PC channel using the push-button channel selector switches, Hot Keys, or via the On-Screen Display (OSD) Menu.

### Disclaimer

This information is subject to change without notice. The producer of this manual accepts no responsibility for damage or claims, resulting from misuse or misinterpretation

## 4. Package Contents

Keyboard Drawer with PS/2 KVM Switch	1 Piece
User's manual	1 Piece
DC Power Adapter	1 Piece
Mounting Bracket	1 Pair
Fasteners	4 Pieces
Key for front access lock	2 Pieces
CD-6 3-in-1 KVM cable	4 Pieces for RK-401
	8 Pieces for RK-801/1601

### Before Unpacking

It is very important to locate the Keyboard Drawer with PS/2 KVM switch in a suitable environment.

- The surface for placing and fixing the Keyboard Drawer with PS/2 KVM switch should be stable and level or mounted into a suitable cabinet.
- Make sure the place is ventilated and out of direct sunlight, away from sources of excessive dust, dirt, heat, water, moisture and vibration.
- Convenience for connecting the Keyboard Drawer with PS/2 KVM switch to the related facilities should be well considers too.

### Unpacking

The Keyboard Drawer with PS/2 KVM switch comes with the standard parts shown as above. Check and make sure they are included and in good condition. If anything is missing, or damage, contact the supplier immediately.

## 5. Optional Accessories

<b>KVM Cable</b>	
CD-6 / 10 / 15	6ft / 10ft / 15ft PS/2 3-in-1 cable
<b>Cascade Cable</b>	
CA-2 / 6 / 10 / 15	2ft / 6ft / 10ft / 15ft PS/2 3-to-3 cable
<b>Conversion Adapter</b>	
SUN-31	SUN / iMAC USB to PS/2 adapter

## 6. Peripheral Products

<b>Model</b>	<b>Description</b>
RP115	1U 15" LCD Monitor Drawer
RP615 / 717 / 819	6U(15") / 7U(17") / 8U(19") LCD Monitor
CV-401	1U 4-Port PS/2 KVM switch
CV-801	1U 8-Port PS/2 KVM switch
CV-1601	1U 16-Port PS/2 KVM switch
CV-101	CAT.5 PS/2 KVM extender

## 7. Important Safeguards

Please read all of these instructions carefully before you use the device.  
Save this manual for future reference.

- Unplug the Keyboard Drawer with PS/2 KVM switch from the power outlet before cleaning.
- Do not spray liquid cleaners or aerosol directly on the device. Wet a cloth with a neutral detergent (e.g. clean water) and squeeze it tight, then clean the screen slightly with it.
- Do not expose the Keyboard Drawer with PS/2 KVM switch directly to rain, water, moisture or sunlight.
- Do not attempt to service the device yourself. Improper operation may void your warranty. Refer all servicing to qualified service personnel.
- Safe storage environment of the Keyboard Drawer with PS/2 KVM switch is ranging between  $-20^{\circ}\text{C}$  and  $60^{\circ}\text{C}$ . Permanent damage could occur if the Keyboard Drawer with PS/2 KVM switch is stored outside the safe range.
- Unplug the Keyboard Drawer with PS/2 KVM switch immediately and call a qualified service personnel under the following conditions:
  1. If the Keyboard Drawer with PS/2 KVM switch has been exposed to rain, liquid or water.
  2. If the Keyboard Drawer with PS/2 KVM switch has been dropped or the casing has been damaged.

### What the warranty does not cover

1. Any product, on which the serial number has been defaced, modified or removed.
2. Damage, deterioration or malfunction resulting from:
  - a) Accident, misuse, neglect, fire, water, lightning, or other acts of nature, unauthorized product modification, or failure to follow instructions supplied with the product.
  - b) Repair or attempted repair by anyone not authorized by us.
  - c) Any damage of the product due to shipment.
  - d) Removal or installation of the product.
  - e) Causes external to the product, such as electric power fluctuation or failure.
  - f) Use of supplies or parts not meeting our specifications.
  - g) Normal wear and tear.
  - h) Any other causes which does not relate to a product defect.
3. Removal, installation, and set-up service charges.

## 8. Structure Diagram

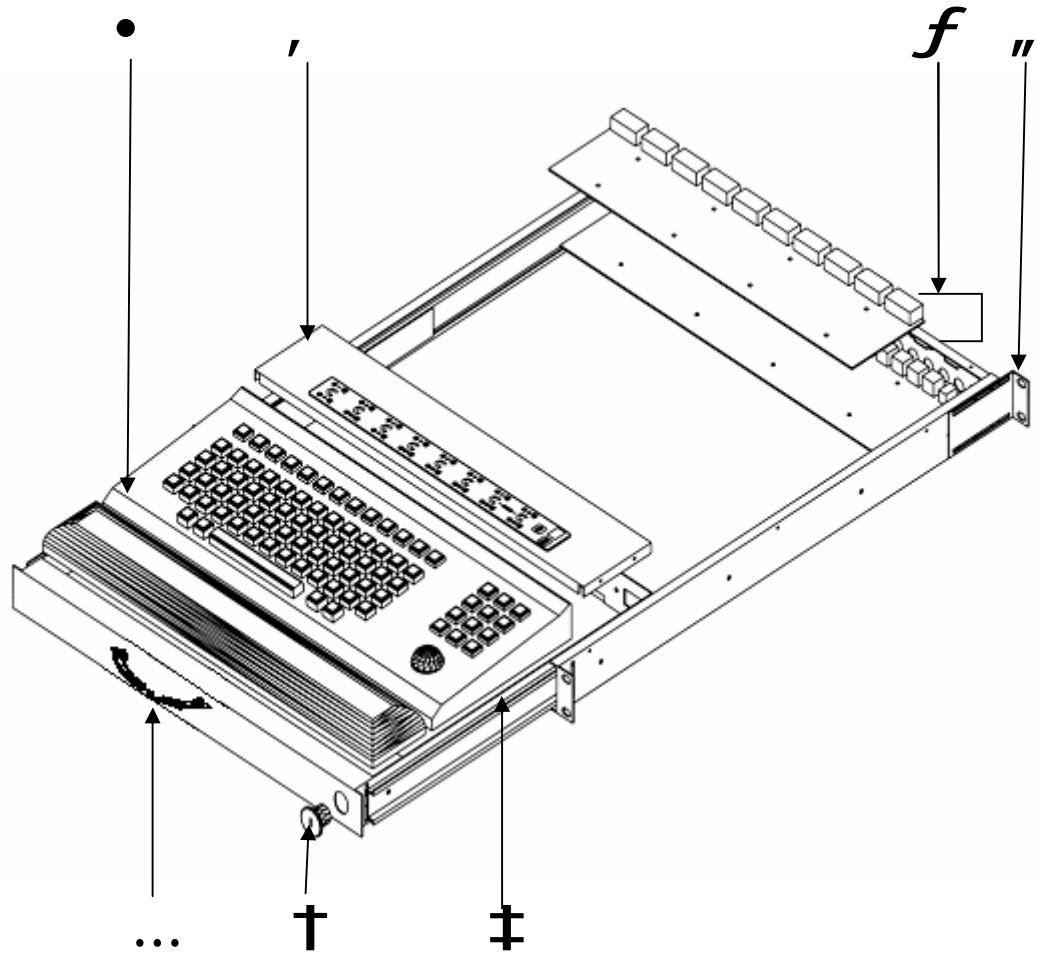

1. PS/2 keyboard with trackball
2. KVM membrane
3. KVM boards
4. Adjustable mounting bracket
5. Front handle
6. Security lock
7. Ball bearing telescopic slides with stopper

## 9. Dimension Diagram

### RK-401 / 801 / 1601

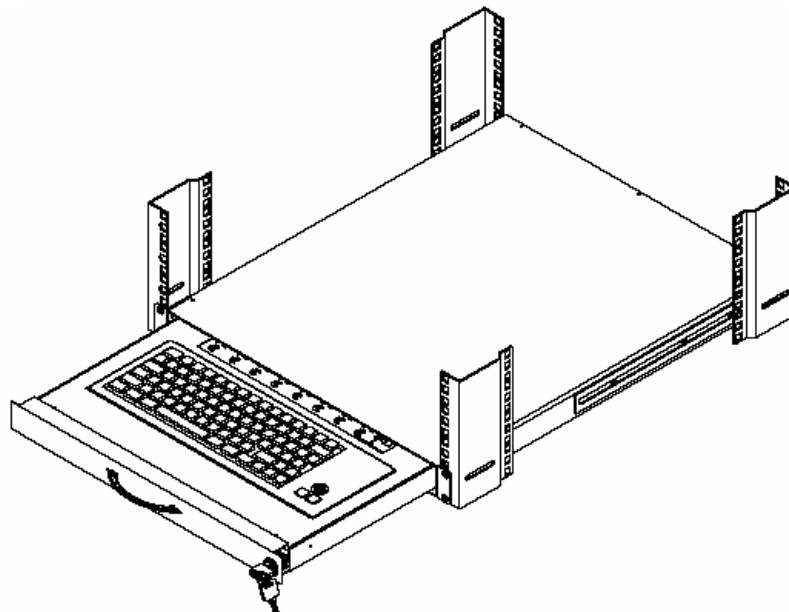
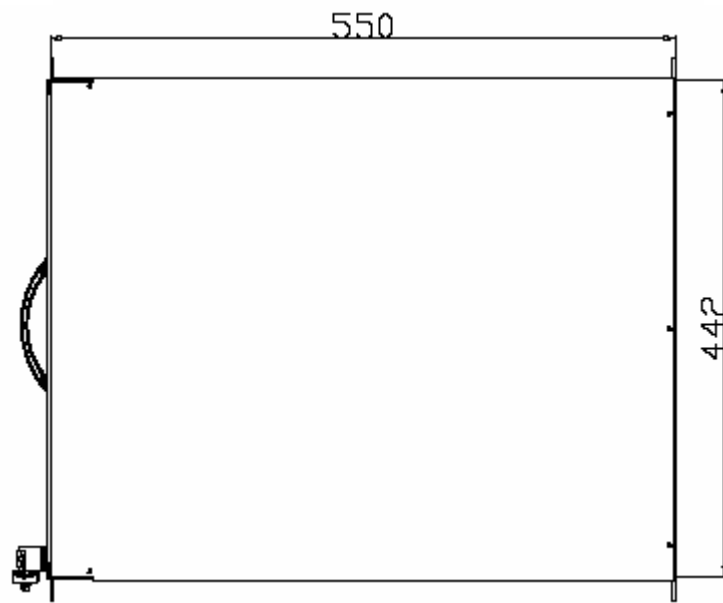
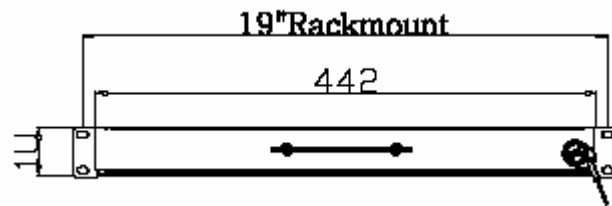
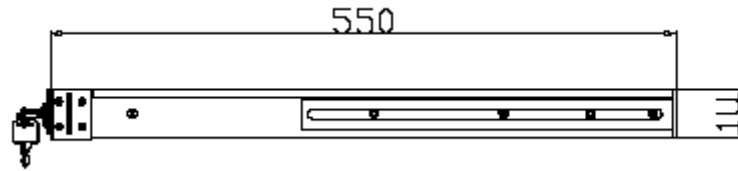

## 10. Keyboard Layout

### Cherry Keyboard with trackball

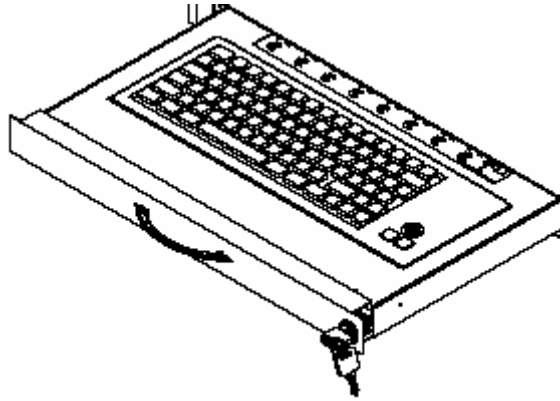

### Compact Keyboard with trackball

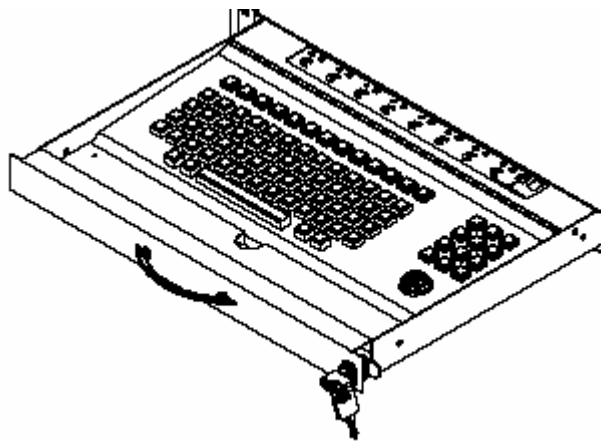

### Notebook Keyboard with touchpad

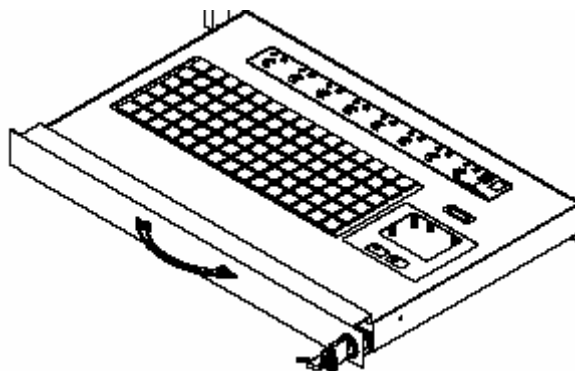

## 11. KVM Session

### Front View

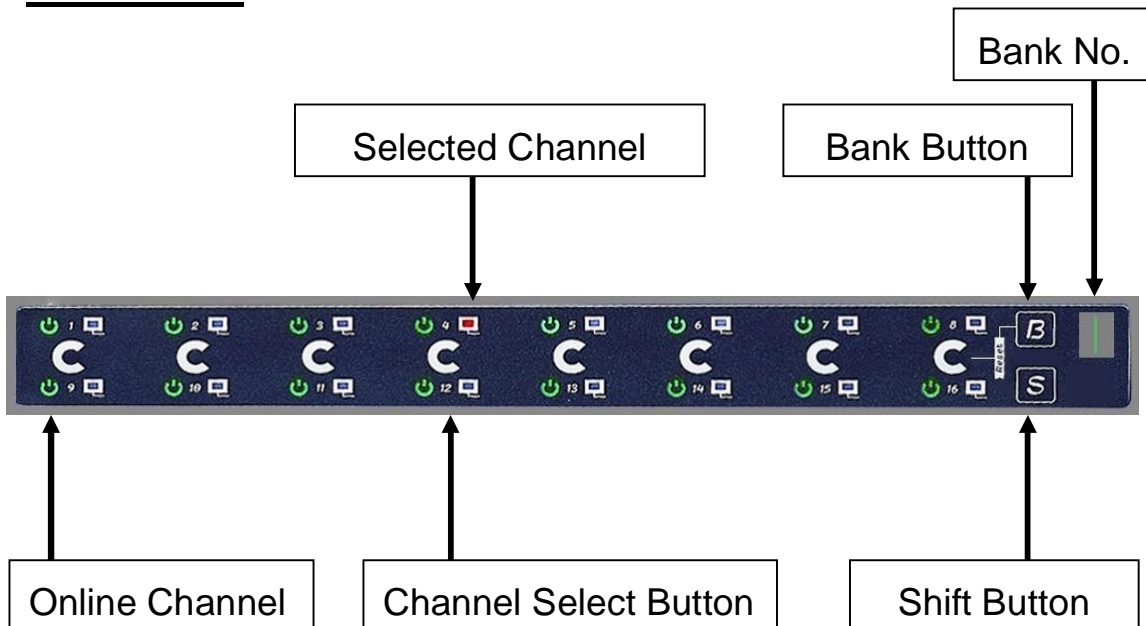

### LED Indication

- Selected Channel - Displayed channel on monitor & red in LED.
- Channel select button - Press to select channel from 1 – 8.
- Shift button - Press & Hold follow with a channel button to select channel from 9 – 16.
- Online Channel - Green LED state the PC has connected and power on.
- Bank No.. - Display the Bank no. from 1 – 8.
- Bank button - Select the bank from 1 – 8 (for cascade only)

# 11. KVM Session

## Rear View

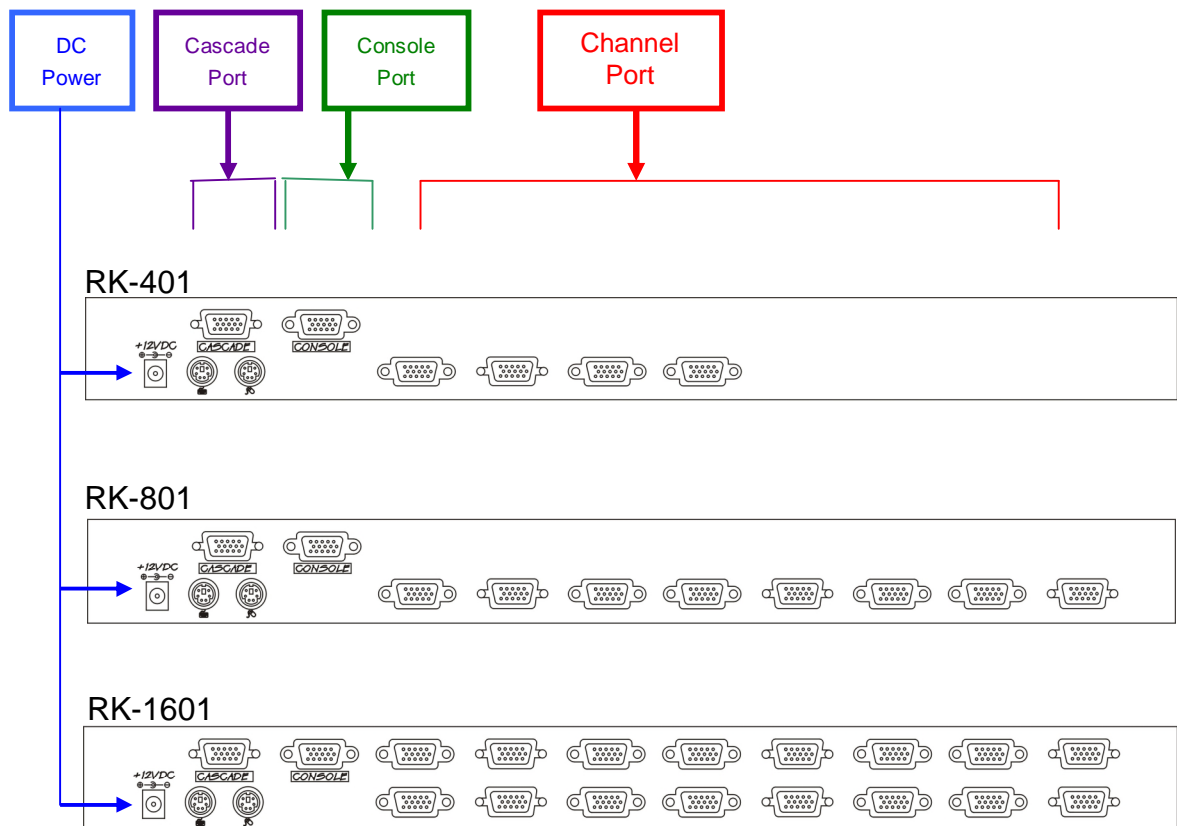

- DC Power** -connect to external 12V DC power adapter.
- Cascade Port** -connect to additional KVM switch for channel expansion.
- Console Port** - connect to monitor.
- Channel Port** - connect to PC computer with CD-6 3-in-1 KVM cable.

## 11. KVM Session

### Installation Steps

Before installation, please make sure all of peripherals and computers have been turned off.

1. Connect the 3-in-1 cable with 2 mini-din 6-pin connectors and a HDDB 15-pin connector to the computer ports.
2. Connect another end of the cable to KVM switch.
3. Connect a monitor to the console port of the switch.
4. Plug the power adapter included to the switch.
5. After powering on computers and finishing the boot-up process, you can start keyboard drawer with PS/2 KVM switch.

**Note:** Please don't switch the PC port (i.e. Don't press the push button of KVM switch or run hot key) during the computers are under boot-up.

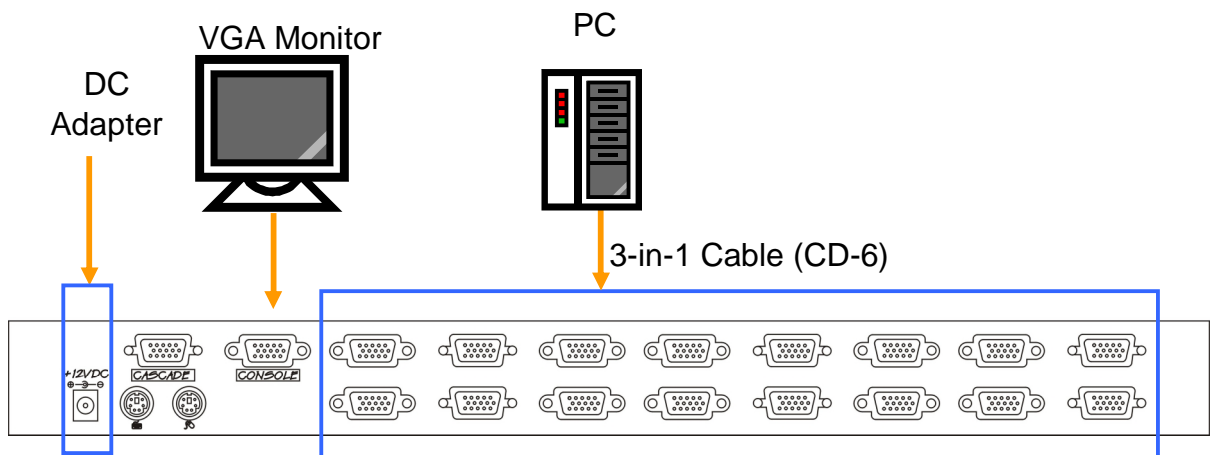

## 11. KVM Session

### Cascading

Using CA-6 PS/2 KVM cable to connect from Bank 1's "Cascade port" to Bank 2's "Console port". After connected please press "Bank" & "Channel" button on the front of the PS/2 KVM switch to reset the PS/2 KVM switch.

#### Bank 1

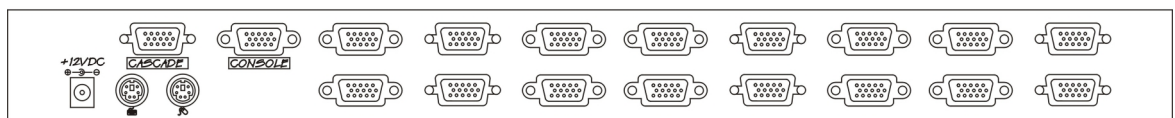

#### Bank 2

CA-6 PS/2 KVM cable

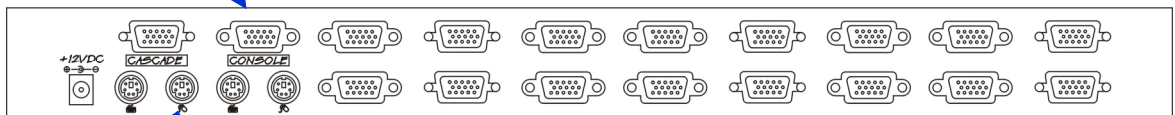

#### Bank 8 (Max.)

CA-6 PS/2 KVM cable

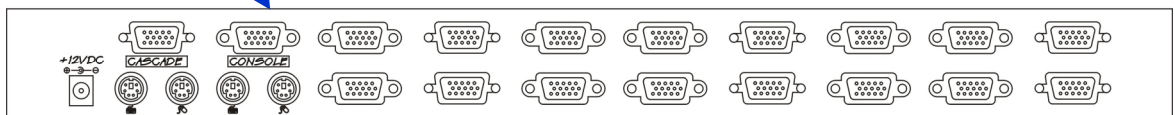

### **Cascade level Max. : 8 level**

- Max. PC connection is 128 or with additional 122 PCs.
- All PS/2 KVM switch is compatible & can cascade with each other.
- Using CA-6 PS/2 KVM cable to cascade.
- Normal distance from one PS/2 KVM to another is 15 feet.

## 12. Start Up

1. The channels that have PC connected and it is switch on will have a green LED on that channel.
2. The red LED will indicate the selected channel.
3. 7 segments LED will display the bank number.
4. Press channel button to select the channel.
5. Enter the password, default is "00000000" eight zeros. Otherwise the keyboard & mouse will be locked.
6. If you forget your password, send back to Manufacturer.

### Hot Key Command

- Simple key sequence.
- Press " Scroll Lock" twice within 2 seconds.
- Follow with a beep sound, going into the hot key mode.
- Need to key in the hot key within 2 seconds.
- Go back to Operation System Control state.

## 12. Start Up

### Hot-key Command Operation

#### 1. Calling OSD Menu

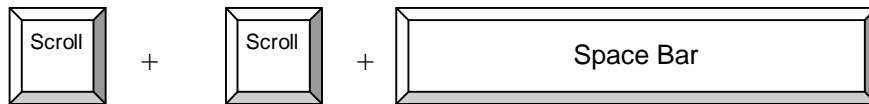

#### 2. Switch to Previous Port (powered on PC only)

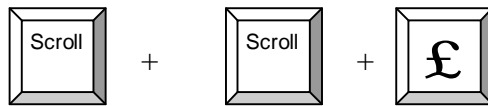

#### 3. Switch to Next Power On Port (powered on PC only)

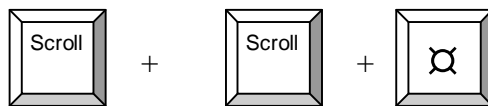

#### 4. Switch to Previous Bank

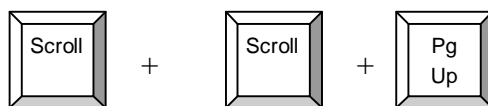

First digit of Port Number:

0 for Port 0-9

1 for Port 10-16

Second digit of port Number

#### 5. Switch to Specific Port

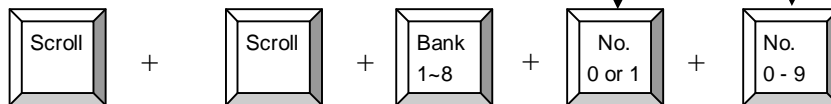

Example :

a) Bank 1 Port 4

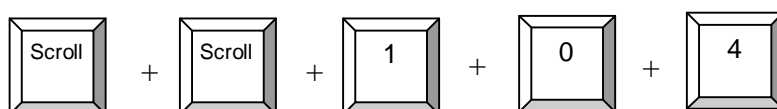

b) Bank 2 Port 16

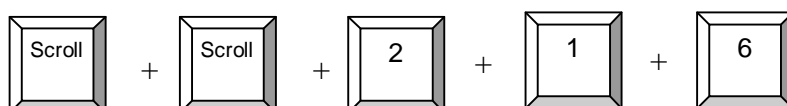

## 12. Start Up

### HotKey Command Operation

#### 6. Switch to Next Bank

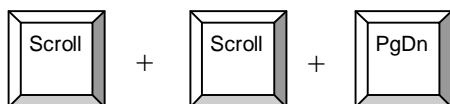

#### 7. Enable / Disable beeper sound

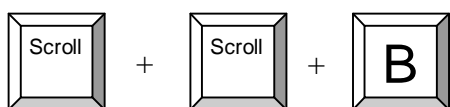

**Note:** The default Beeper function is ON and beeper control is only for

#### 8. Auto Scan for Powered on PC

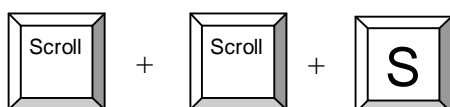

#### 9. Reset to factory Default Setting

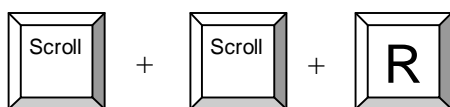

**ROM REFLASH**

**Note:** Not available for password reset.

#### 10. Find Port by name

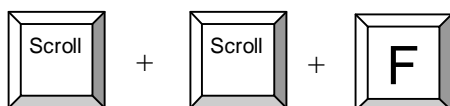

**FIND:**

**Note:** When the above dialogue appear, type the PC name and the OSD Menu will search PC name starting from 1<sup>st</sup> powered on PC port.

## 12. Start Up

### OSD Structure Diagram

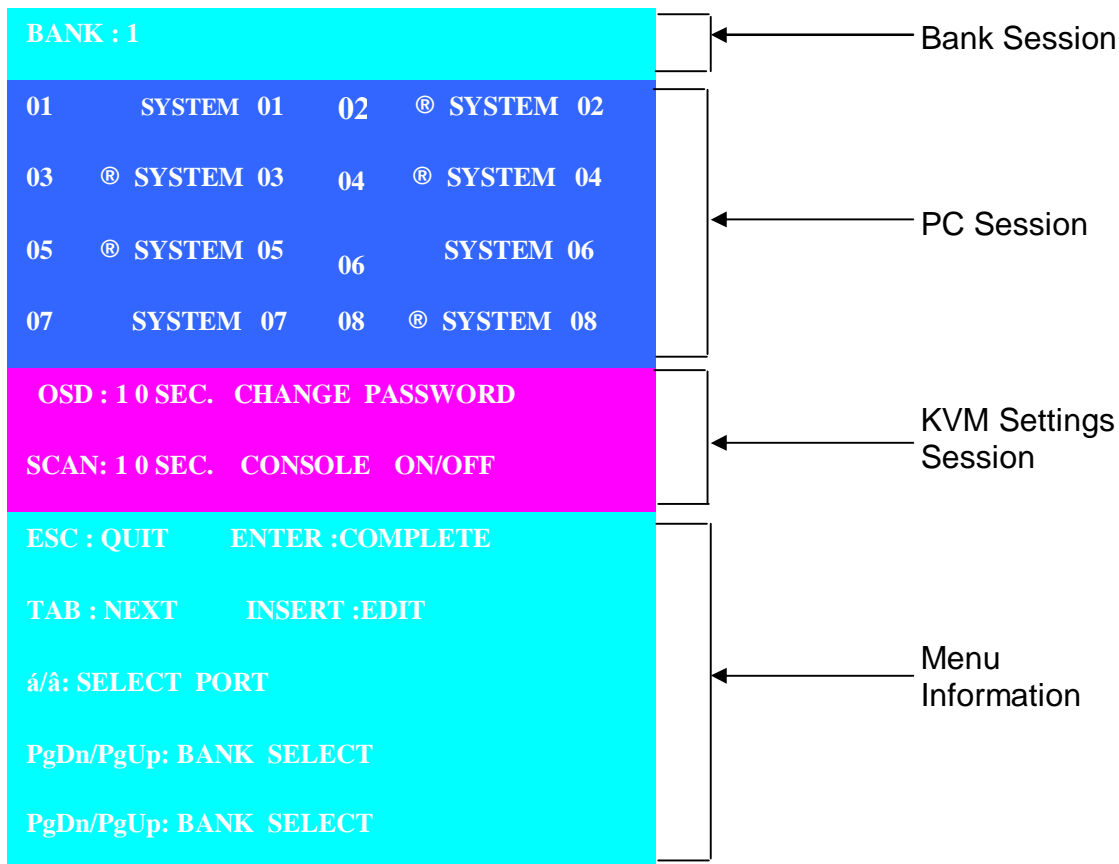

### OSD Menu Operation

Use “**Tab**” key to select session like Bank, PC, OSD, SCAN, CHANGE PASSWORD, CONSOLE ON/OFF, etc...

#### Bank Session

Use **Page Up** & **Page Down** to switch previous or next bank

#### PC Session

1. “®” next to the PC name represents the PC system is powered on
2. Use up arrow key “á” or down arrow key “â” to select port for destination PC name and press “**Enter**” to select
3. Edit PC name - Press “**Ins**” key for editing PC name

**Note:** PC name should not be more than 8 characters.

4. When editing is finished press “**Enter**”.

## 12. Start Up

### KVM Settings Session

1. OSD
  - OSD Menu on screen time default is 10 seconds.
  - It can be modified from 05 – 99 seconds.
  
2. Scan
  - Scan interval from one PC port to next PC port when applying auto scan, its default is 10 seconds.
  - It can be modified to 99 seconds for maximum.
  
3. Change Password
  - Default password “00000000” 8 zeros
  - Choose “Change Password” in KVM Setting Session.
  - Key-in the existing password.
  - Enter the New Password.
  - Re-Enter the New Password.
  - Changing Password complete.
  - The steps are shown as next picture:
  
4. Console On/OFF
  - ON – any user can use the console
  - OFF – user is not allowed to use the console port, unless password is entered.
  - Default – OFF, you need to key-in password.
  
5. Escape
  - When the following screen is appeared, you can press “ESC” key to escape.

**ENTER PASSWORD : █**

---

**ESC : QUIT      ENTER :**



**ENTER NEW PASSWORD : █**

---

**ESC : QUIT    ENTER : COMPLETE**



**RETYPE NEW PASSWORD : █**

---

**ESC : QUIT    ENTER : COMPLETE**



**NEW PASSWORD COMPLETE**

---

**ESC : QUIT    ENTER : COMPLETE**

**102    ?SYSTEM 02**

## 13. FAQ

1. Don't press any keys on the keyboard while the selected computer is booting up. Otherwise, it might cause the keyboard error or keyboard is not detected at PC side.
2. The computer boot up fine, but keyboard doesn't work.
  - Make sure the keyboard works when directly plugged into the computer.
  - Try a different keyboard, but use only 101, 102 or 104-key keyboard.
3. The Mouse is not detected during PC boot up.
  - Make sure the mouse works when directly plugged into the computer.
  - Make sure the mouse is a true PS/2 mouse. A combo mouse will work just as long as it is set for PS/2 mode with the correct adapter. Try a different mouse.
  - Avoid moving the mouse or pressing the mouse buttons when switching ports.
  - Avoiding switching ports during shutting down the PC process.
  - When you switch one PC port to another PC port, the best scan time setting need to be set to 5 seconds or more. Normally, the VGA monitor change one resolution mode to another will take one or two seconds. So, the scan time is not recommended to below 5 seconds.
4. Sun Server connection problem.

PS/2 KVM switch are using standard PS/2 type keyboard, mouse and D-sub 15pin VGA for connection. If you need to connect Sun Server to PS/2 KVM switch, you need a separate converter kit.
5. Sun – 31 Kit
  - Convert USB to P/S 2 Keyboard & Mouse.
  - New model Sun Micro Server are using D-sub 15 pin Standard VGA.

## 14. Technical Specification

Item	Specification
KVM Channel Port	RK-401: 4 port / RK-801: 8 port / RK-1601: 16 port
KVM Channel Interface	HDDB 15 pin
PC Computer Interface	PS/2 Keyboard: Mini Din 6 pin Female
	PS/2 Mouse: Mini Din 6 pin Female
	VGA : HDDB 15pin Female
Cascade Port Connector	PS/2 Keyboard: Mini Din 6 pin Female
	PS/2 Mouse: Mini Din 6 pin Female
	VGA: HDDB 15pin Female
KVM Cable Connection	3-in-one HDDB 15-pin KVM Cable (CD-6/ 10/ 15)
PC selection	On Screen Display, Hot Key & Push Button
LED	1 Bank LED
	4 / 8 / 16 Online LED (Green) & Selected LED (Red)
On Screen Display Control	Yes
Scan Mode Intervals	5~99 Sec.
VGA Resolution	1,920X1,440
Bandwidth	200MHz
Cascade MAX. Level	8 levels with addition 112 PCs connection
Housing	Metal
Power Adapter	DC 12V 1A
Operation Temperature	0~40°C
Storage Temperature	-20 ~ 60°C
Humidity	0~80%, Non-Condensing
Product Dimension	439 W x 44H x 55D mm
Net Weight	RK-401 : 9 Kg / RK-801 : 9 Kg / RK-1601 : 10 Kg