

# BHK117Ue/BHK119Ue User Reference Manual



## LCD Keyboard Drawer Specification for BHK117Ue/BHK119Ue

<b>Chassis</b>	External Chassis	Industrial Metal Frame
<b>Display</b>	LCD	17", 19" Diagonal
	Resolution	1280 x 1024
	Color	16M colors
	Brightness	300 Nits
	Contrast	500:1
	Viewing Angle	160 H, 160 V
	Protection	Tempered Glass
<b>KVM Switch</b>	Ports	1 port (920), 8 ports (980), 16 ports (990)
	Video Signal	VGA D-Sub 15
	Keyboard Signal	USB (920), PS/2 or USB Combo (980/990)
	Mouse Signal	USB (920), PS/2 or USB Combo (980/990)
<b>Control Button</b>	Port Switch	1x (920), 8x (980), 16x (990)
	LCD Control	4x
	Power	1x Front Standby, 1x Rear Main
<b>Operating system</b>	OS	DOS/Windows/Netware
		SCO/Linux/HP Unix/Solaris
<b>Input Peripheral</b>	Keyboard	105 Key Cherry Switch Keyboard *Optional 117-Key for Sun System
	Pointing Device	Integrated TouchPad
	Pointing Device Button	2x Button *Optional 3x Button for Sun System

### Environmental Specification for SMK 920/980/990

<b>Environmental Specification</b>	Operating Temp	0° C - 50° C
	Relative Humidity	20-80% (non-condensing)
	Shock	10G operating, all axes
	Vibration	1.25G @ 10-100Hz operating, all axes
	Compliance	CE & FCC Class-A
	Safety	UL

<b>Power</b>	Power supply	50W 110VAC ~ 220VAC Auto Switching
<b>Dimensions</b>	H	44mm
	W	442.4mm
	D	600mm
<b>Weight</b>	Net weight	30.5LB (Chassis Weight)
<b>Transport Case</b>	Packaging	Padded foam with box

## 1.0 Introduction

### Rack Dense Chassis Solution

The integration of data and video, and voice communication in computers and the subsequent technological advances have spawned many sophisticated CTI applications that have become accessible and affordable to the small and mid-sized business. The increasing CTI applications coupled with the growing demand for corresponding hardware and systems have created a dilemma: How does one pack the growing number of equipment into existing space.

1U slim industrial monitor keyboard, the BHK, is the solution for compacting more computing power into limited space. This revolutionary monitor keyboard combines a spectacular display coupled with a keyboard with built-in pointing device in a compact unit that measures only 1U in height. Occupying a fraction of the space of traditional monitor and keyboard units, the installation of the BHK leaves ample space for other critical components. With built-in analog-to-digital conversion board, the BHK can be connected to any standard VGA graphics card for immediate on-screen display. The monitor keyboard unit has a built-in slide rail and mounts easily onto any 19" rack mount cabinet.

### Instant Setup

Setting up is no hassle. BHK enables you to be up-and-running in minutes without complicated setup. Our all-in-one design has integrated keyboard, mouse, and display into a total package for your convenience.

### LCD Display Information

The BHK has built-in high resolution LCD screens. With our engineering advancement, LCD can be tilted and retracted fully effortlessly. The BHK is integrated with 17" or 19" high brightness, high contrast and fast response LCD screen.

### KVM Information

The BHK117Ue/BHK119Ue is a single port USB keyboard/mouse connection for connecting to your single server or existing KVM switch box. The BHK117Ue/BHK119Ue comes with built in 8 ports or 16 ports KVM switch. It supports both PS/2 and USB keyboard/mouse connection without having to deal with unwanted adapter. Simple cable solution will carry the VGA signal without input device signal to help rid of unwanted mess. The KVM has integrated OSD and hot key to help control and manage the switch connecting to multiple systems to better productivity in a space saving solution.

### OS Configuration

The BHK117Ue/BHK119Ue will allow you to connect to multiple servers running on different platforms and operating systems. The unit has integrated extra support function key and extra mouse button to better accommodate a wider variety of needs. \*\*Special optional upgrade to allow 117 keys and 3 mouse button for Sun system OS specific.

## 2.0 Installation/Operation

2.1 Insert the LCD Keyboard Drawer into the rack cabinet in the desired position.

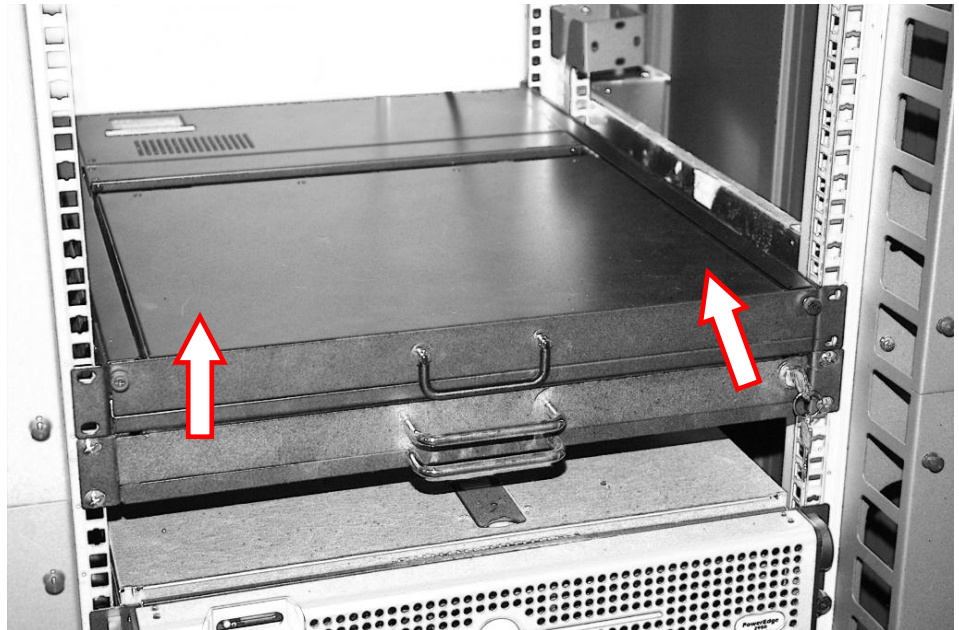

2.2 Attach the 2x rear support bracket and extending into the proper length of the cabinet depth. And secure the 2x bracket on each side with the supplied screw.

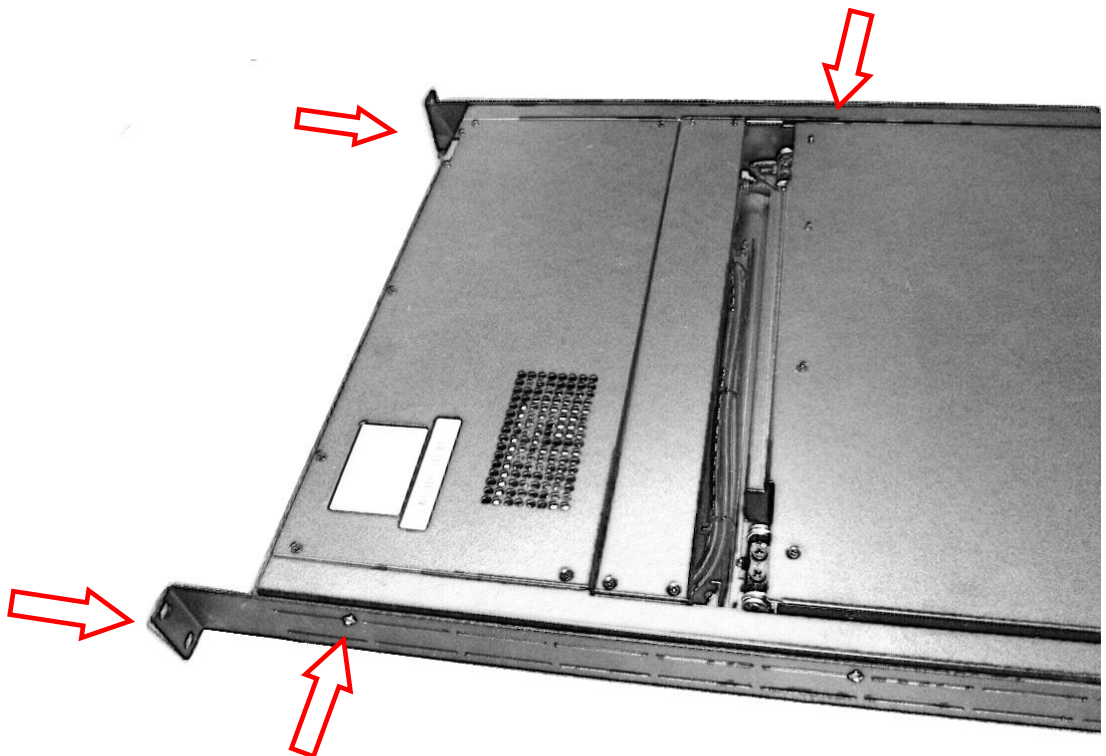

2.3 Secure the rear and front rack mounting to properly mount and fix its position into the cabinet.

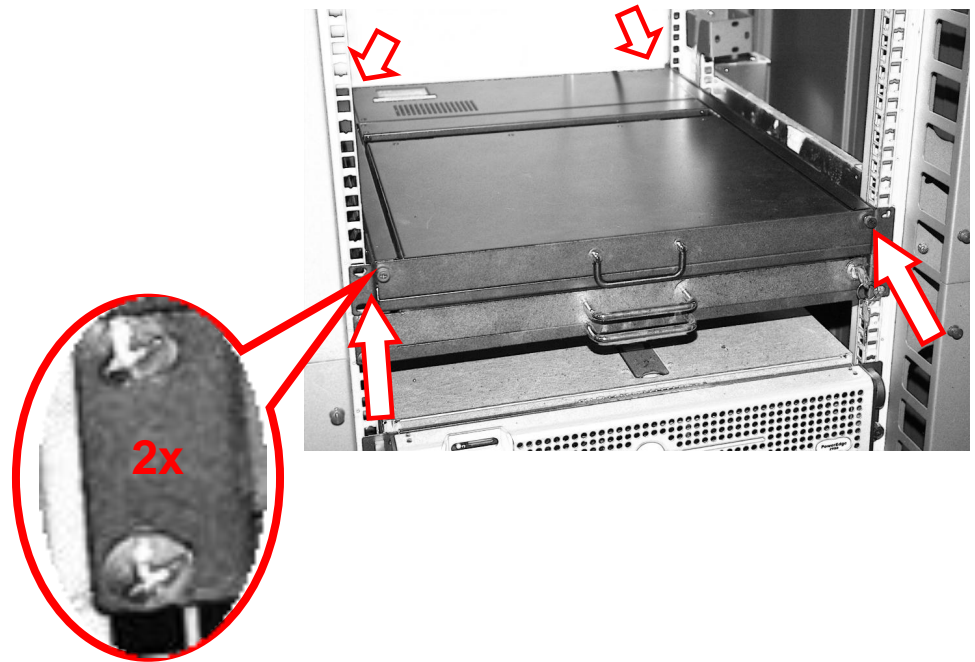

2.4 Connect the AC power cable into rear of the drawer unit.

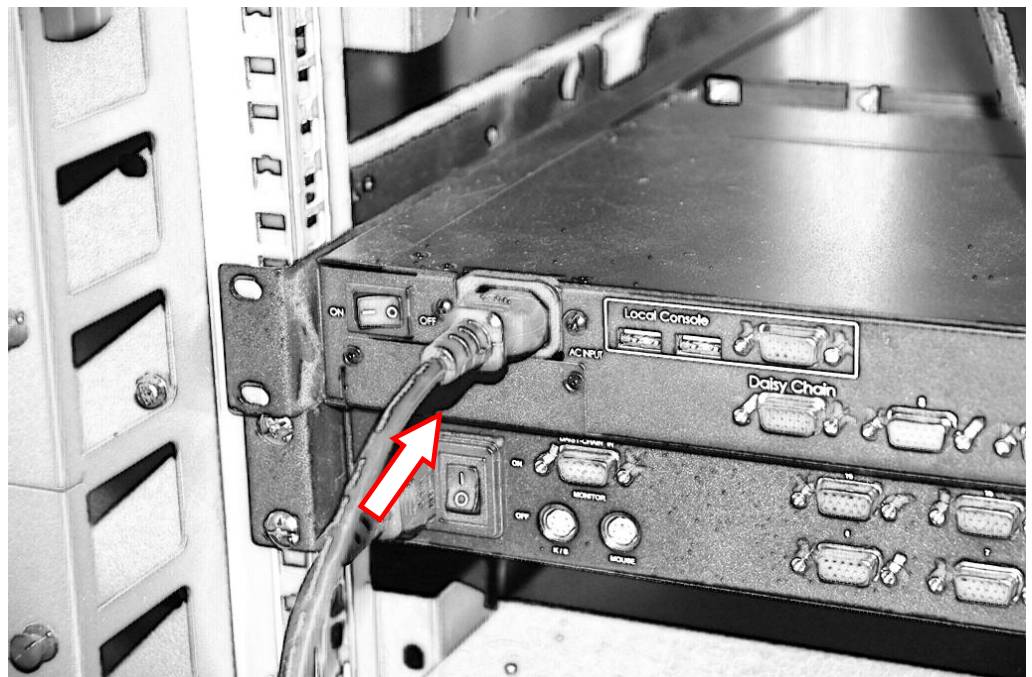

2.5 Connect the host cable to the rear of the drawer. For the BHK117Ue/BHK119Ue, USB type can be connected to its single port. For BHK117-8(16)Ue/BHK119-8(16)Ue both PS/2 and USB type can be use with the KVM, just choose the desire type to match with your system, the KVM accepts both. Refer to **Section 3** for further detail. (\*980 Shown)

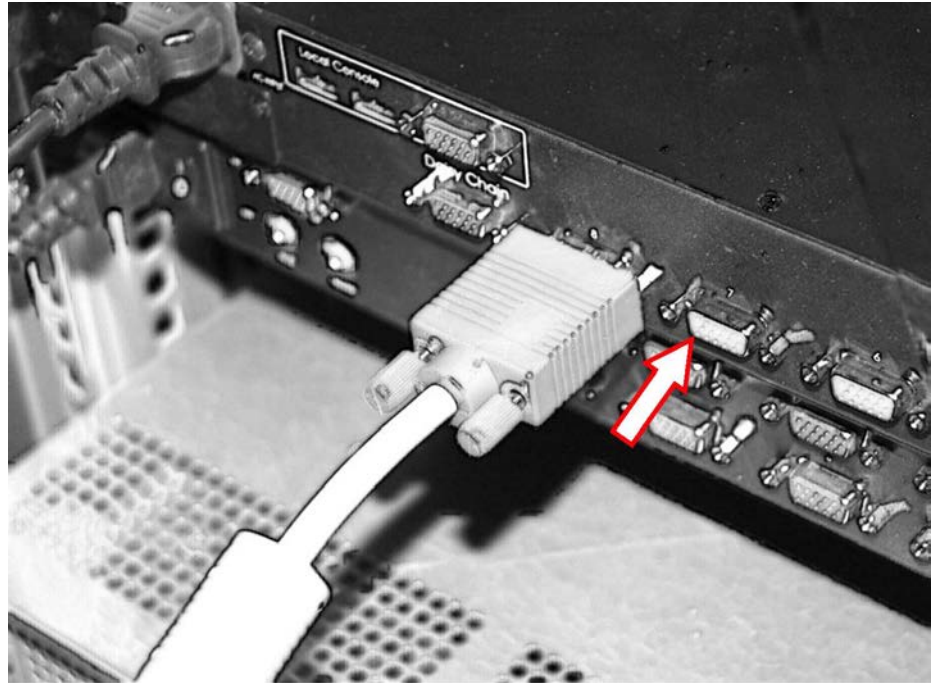

2.6 You can turn on the drawer unit main power on the back of the chassis.

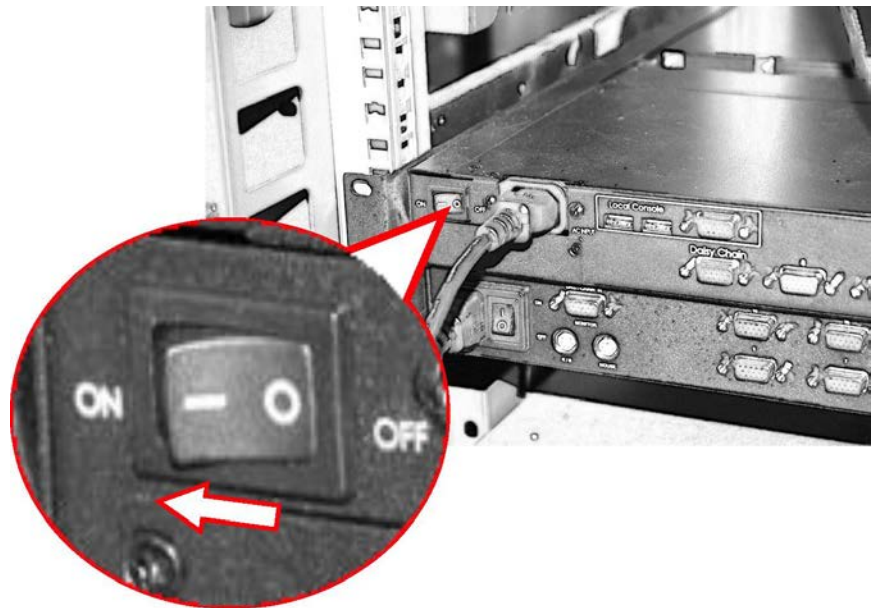

2.7 To open the drawer, unscrew the 2 thumb screw on either side of the front of the unit and pull drawer outward using the handle bar in the center of drawer.

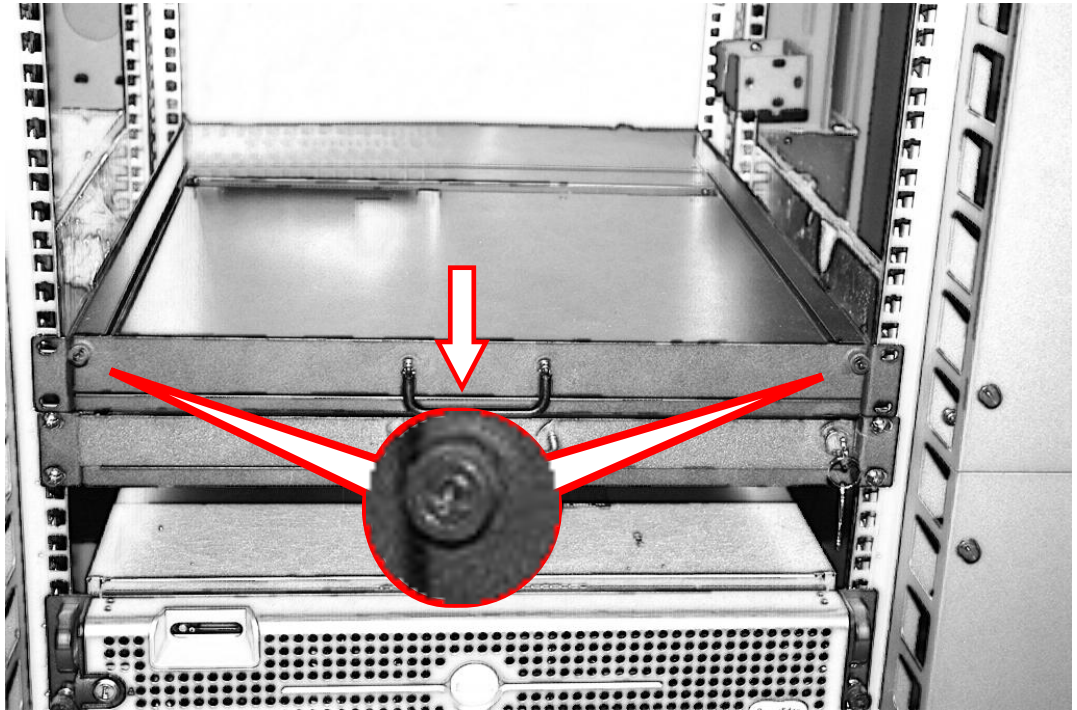

2.8 Once the drawer is fully extended, lift up the LCD panel and tilt back, this will allow you to view the LCD and access the keyboard/touchpad.

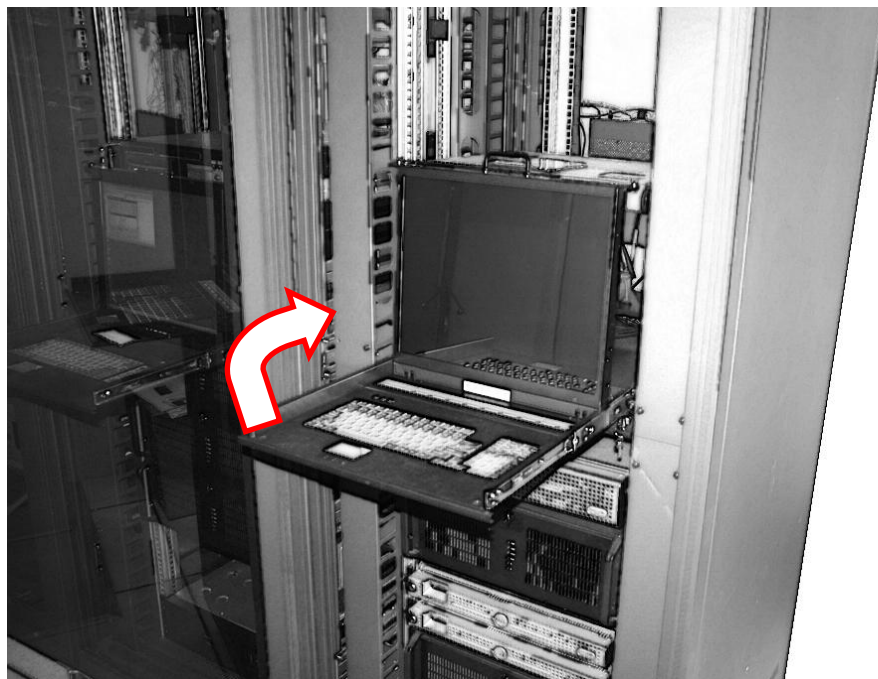

2.9 To turn on the power for the LCD panel, the power button located beneath the LCD can be used to independently turn on/off. LCD screen adjustment button is also located here.



2.10 To return the drawer back to the unit, fold screen down and push in the 2 tap located on each side of the rail then push the drawer back in.

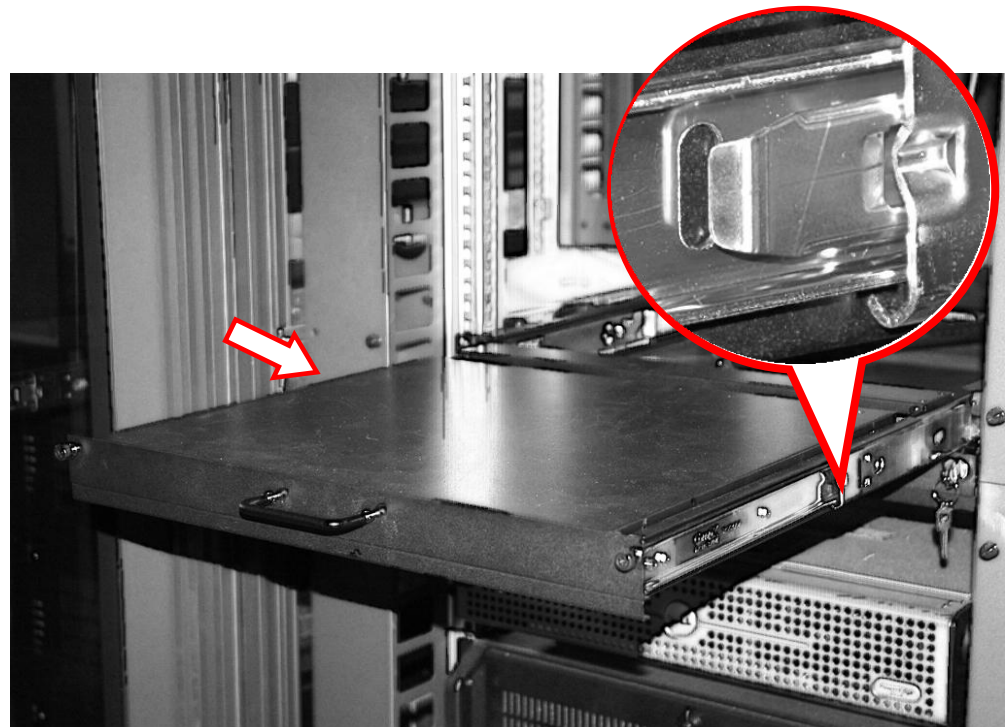



### 3.0 KVM Connection (BHK117-8(16)Ue/BHK119-8(16)Ue Model Only)

3.1 The rear section of the unit will have a series of connections for connecting to systems

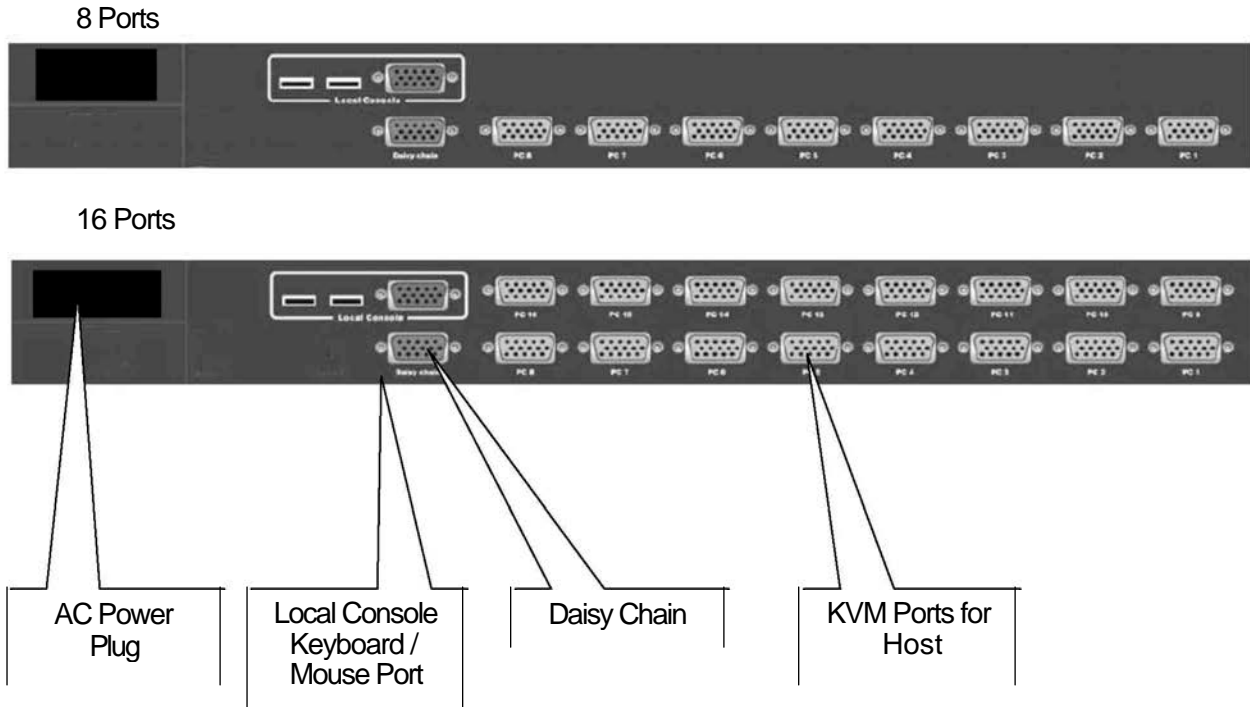

3.2 Connecting KVM Ports for Host using PS/2 connection. Connect single ended D-Sub end to KVM port and other end composing of VGA D-Sub, PS/2 Keyboard (Green) and PS/2 Mouse (Purple) to corresponding ports on the system.

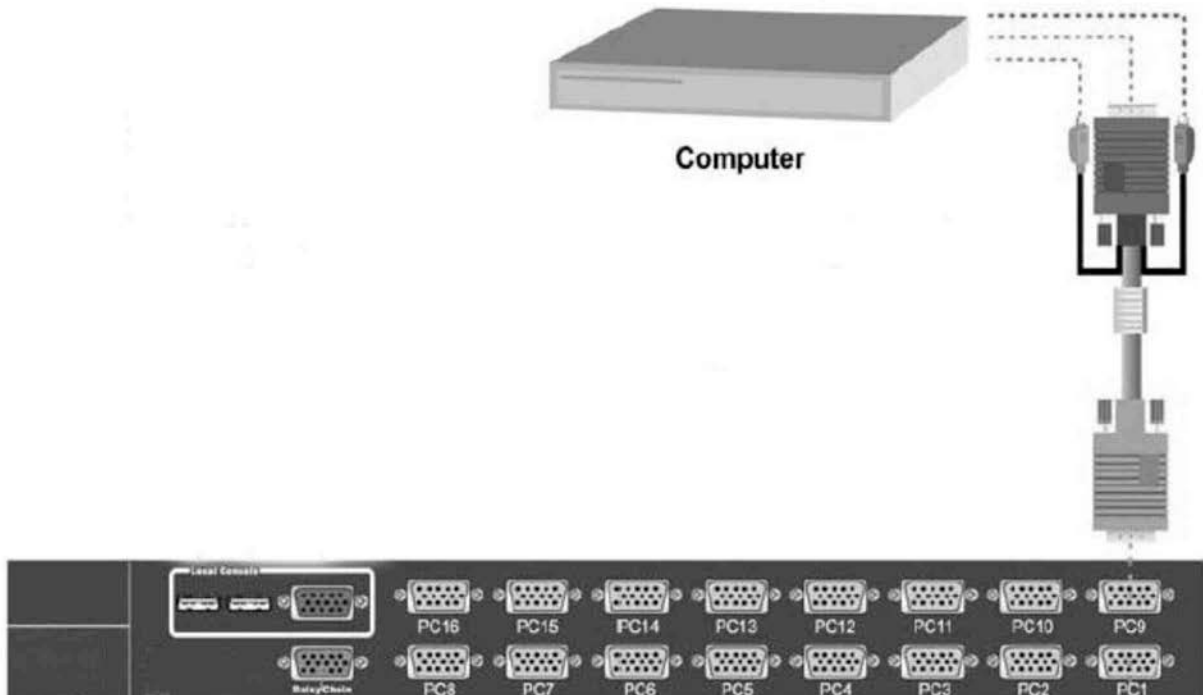

3.3 Connecting KVM Ports for Host using USB connection. Connect single ended D-Sub end to KVM port and other end composing of VGA D-Sub and USB to corresponding ports on the system.

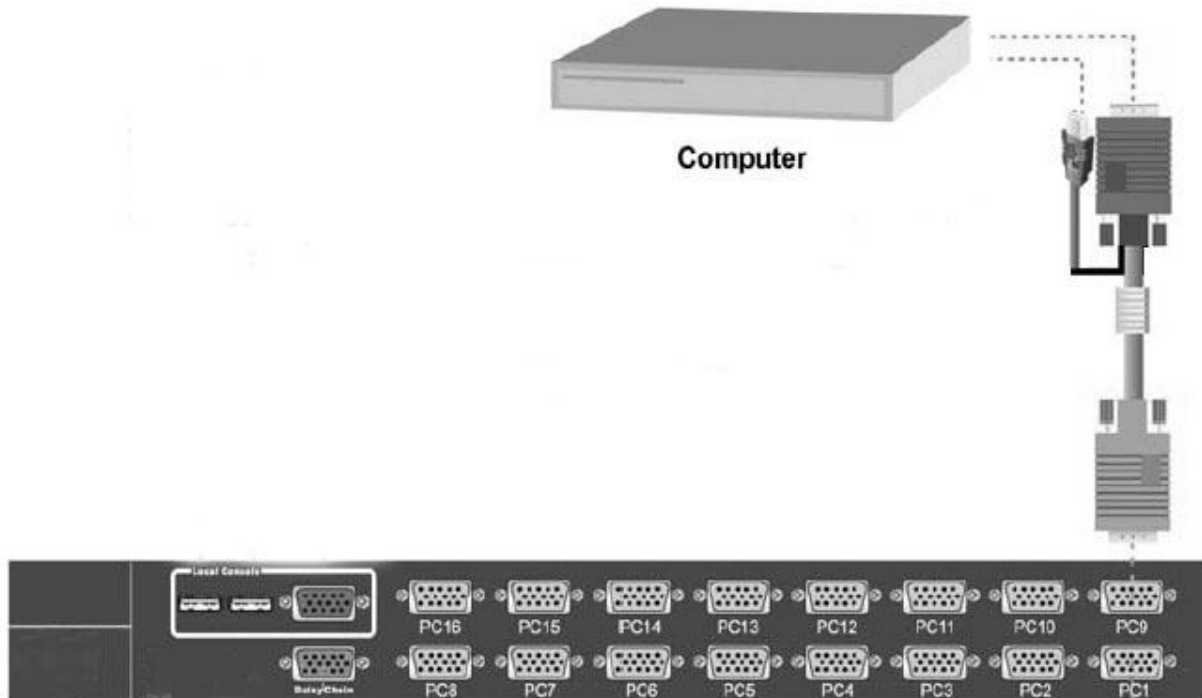

3.4 You can connect a local console port to operate the KVM bypassing the built-in LCD and keyboard/touchpad through the rear local console port. Connect the VGA D-Sub connector and USB keyboard and USB mouse to the port marked.

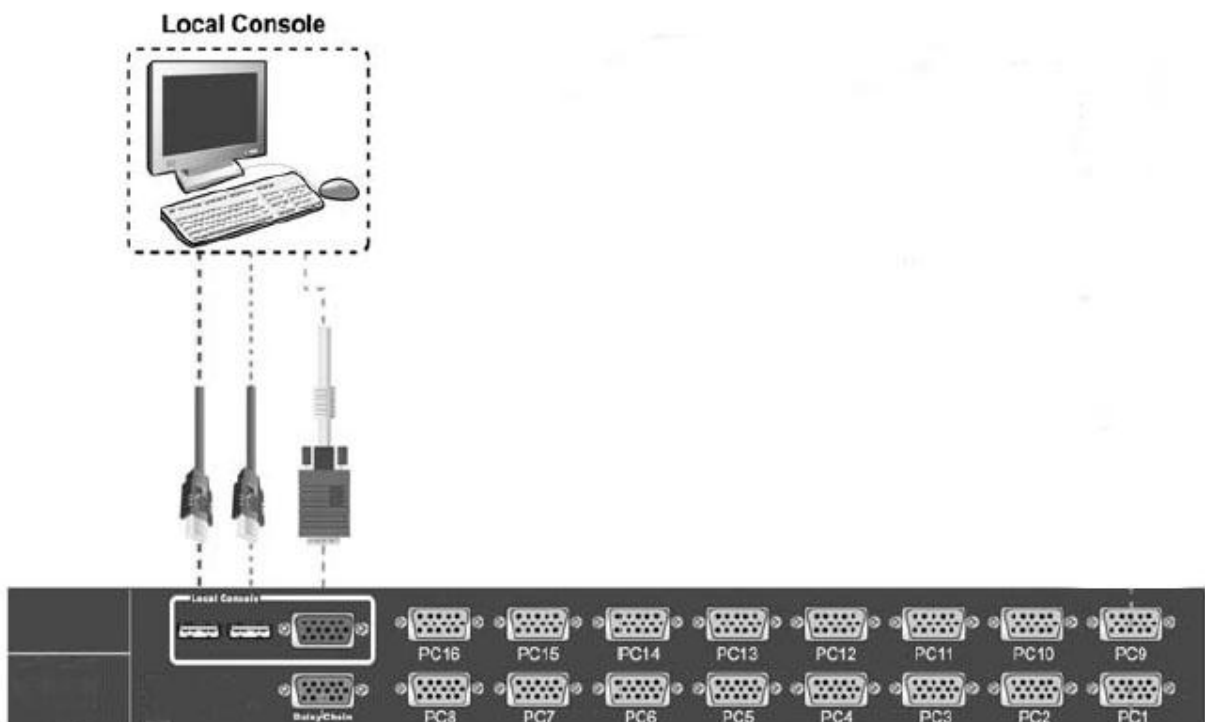

3.5 You can connect additional KVM port by adding additional KVM switches and connecting between them a daisy chain cable. The control will be from the primary KVM by changing banks selection.

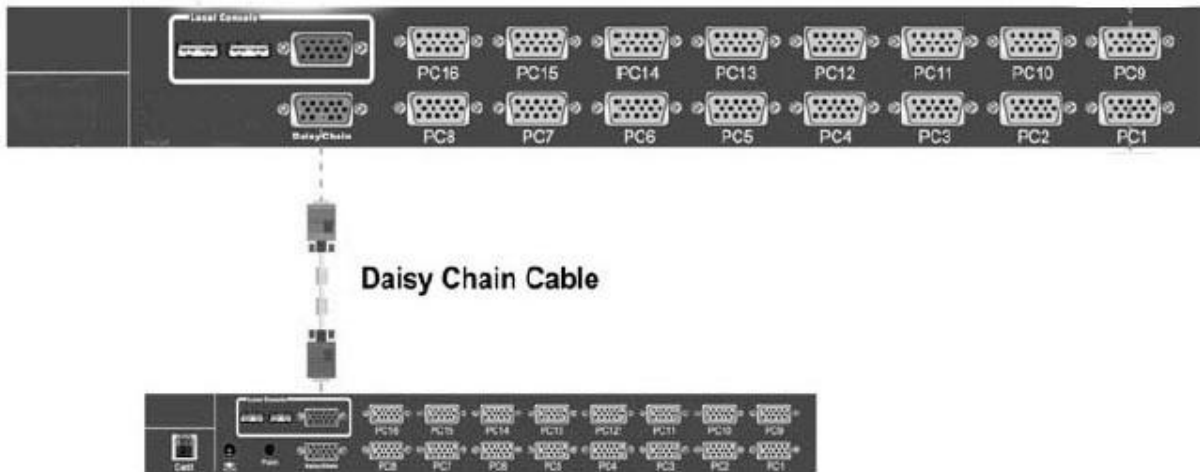

3.6 **Optional CAT5 Transmitter Module Available** to connect system or remote console via CAT5 Extender for long distance connection up to 1000 feet.

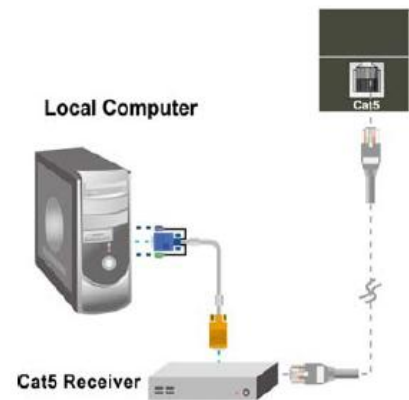

3.7 **Optional IP Remote Console Module Available** for allow redirect of keyboard, mouse and mouse data to a remote administration console. It allows you to control one or many computer locally at the server site or remotely via the Internet using standard browser.

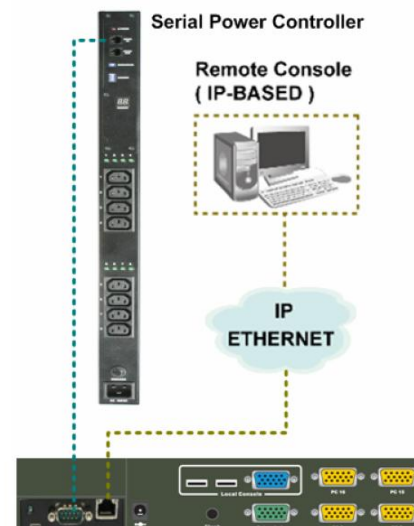

## 4.0 KVM OSD Operations (BHK117-8(16)Ue/BHK119-8(16)Ue Model Only)

- 4.1 When powering up the unit it is required that you provide authentication to access the KVM control for all systems connected to the unit. The default user name is **00000000** and the default password is **00000000**

The Login window

U	S	E	R		N	A	M	E
P	A	S	S	W	O	R	D	

- 4.2 After login the screen will display status of the current setting. This will give you information regarding the port (name) and key setting. Pressing any key will remove the status display.

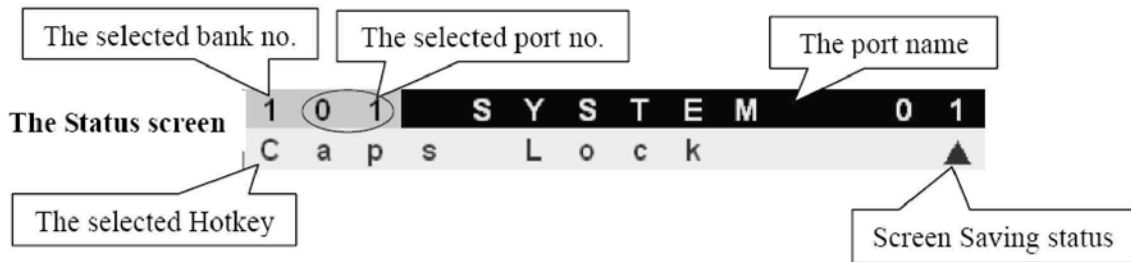

- 4.3 You can bring up the KVM OSD by pressing the **Cap Lock** key twice and then **Space Bar**.



4.4 The first page display will show the OSD menu that allows you to choose the main general options you would like to proceed.

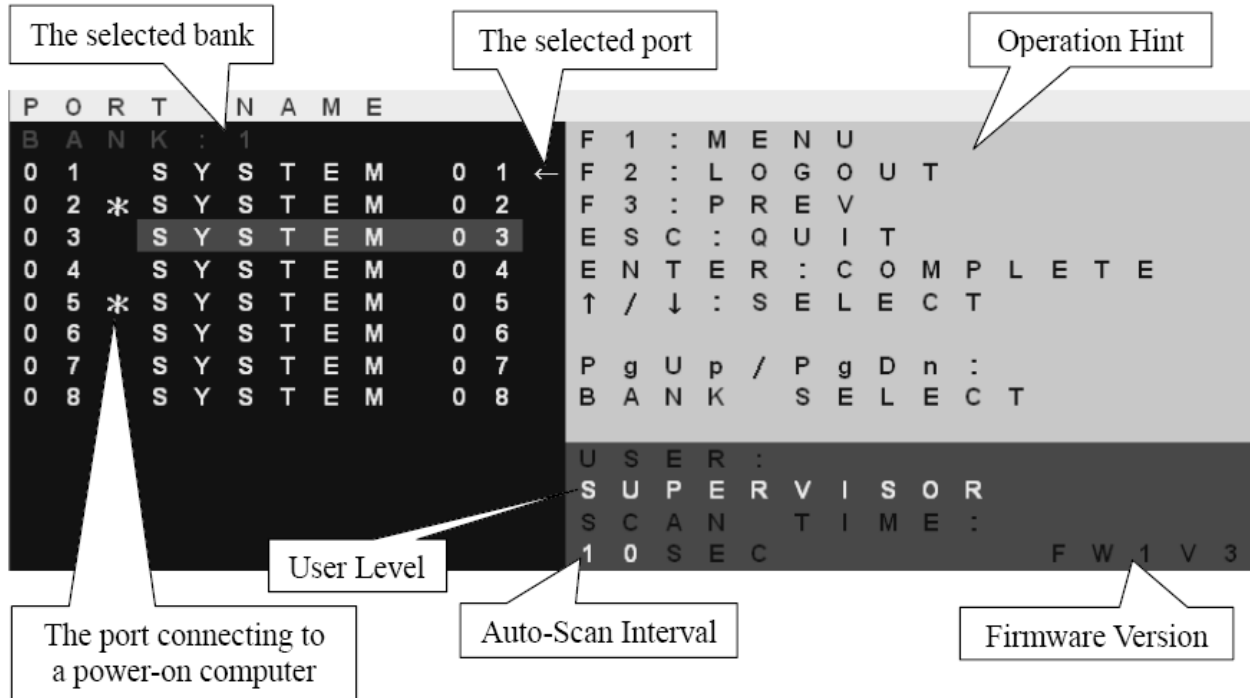

4.5 Following are list of function key to access each of the action.

OSD Function Key	Description
F1	Go to the Main Menu
F2	To log out the OSD. If Security is enabled it will show up the Login window waiting for username and password. If Security is disabled it will show up the Status window
F3	Previous Menu
Enter	Switch to the selected port
↑ or ↓	Moving Up or Down
PgUp	Previous Bank
PgDn	Next Bank
Esc	Exit
1	Show ports 01 ~ 08
2	Show ports 09 ~ 16
3	Show ports 17 ~ 24
4	Show ports 25 ~ 32

4.6 The bottom right portion of the OSD gives the status of the user login and setting.

**USER** --- There are two types of user levels: **SUPERVISOR** and **USER**. The default is **SUPERVISOR**. **SUPERVISOR** can setup and change the OSD settings at Main Menu. **USER** can only do the port switch and port search.

**SCAN TIME** --- This is the time interval for auto-scan function. When auto-scan function is activated, the KVM switch will auto-scan the host port one by one in the interval as setting. Notice that the port without connecting to a computer/server will be skipped over on the scan. The numeric keypad is not supported, while in OSD screen, the arrow keys, PgUp, PgDn, and Enter keys are supported.

4.7 By going into the menu, you will receive a new list of functions.

M A I N M E N U										
S E L E C T O P T I O N :										
0 1	L A N G U A G E									
0 2	P O R T		N A M E			E D I T				
0 3	P O R T		S E A R C H							
0 4	U S E R		S E C U R I T Y							
0 5	A C C E S S		L I S T							
0 6	H O T K E Y									
0 7	T I M E		S E T T I N G S							
0 8	O S D		M O U S E							

4.8 The language selection allows you to choose the desired display language for reference.

\*\*Non-Latin based language are for display purpose only and not for editing

L A N G U A G E									
C H O O S E A L A N G U A G E :									
0 1	E N G L I S H								
0 2	F R E N C H								
0 3	G E R M A N								
0 4	I T A L I A N								
0 5	S P A N I S H								
0 6	S I M P L I F I E D		C H I N E S E						
0 7	J A P A N E S E								
0 8	R U S S I A N								



Press the **Enter** key or left button of mouse for editing. The left-top “S” means SUPERVISOR, and “1”, “2”, “3”,....., “8” mean USERS. The maximum length of NAME and PASSWORD is eight characters (A~Z and 0~9).

Press **Enter** key to start the editing. After the editing, press **Esc** key to cancel the editing without any change or press **Enter** key to save the setting.

**HINT1:** Blank has underscore, while SPACE doesn't have.

**HINT2:** Hit any alphanumeric key so can move to next input item. SPACE is treated as a valid character

**HINT3:** At default, all USER's username = SPACE and password = SPACE, but they are invisible, so anyone can use SPACE SPACE to log in.

4.12 The access list allows you to assign user right to each port. Only the supervisor can configure the access list. Use the Enter key to toggle the port right, where O means enable and X means disable.

A C C E S S L I S T													← X					
B A N K	:	1	2	3	4	5	6	7	8	1	2	3	4	5	6	7	8	
0 1	S	Y	S	T	E	M	0	1	0	0	0	0	0	0	0	0	0	0
0 2	S	Y	S	T	E	M	0	2	0	0	0	0	0	0	0	0	0	0
0 3	S	Y	S	T	E	M	0	3	0	0	0	0	0	0	0	0	0	0
0 4	S	Y	S	T	E	M	0	4	0	0	0	0	0	0	0	0	0	0
0 5	S	Y	S	T	E	M	0	5	0	0	0	0	0	0	0	0	0	0
0 6	S	Y	S	T	E	M	0	6	0	0	0	0	0	0	0	0	0	0
0 7	S	Y	S	T	E	M	0	7	0	0	0	0	0	0	0	0	0	0
0 8	S	Y	S	T	E	M	0	8	0	0	0	0	0	0	0	0	0	0

4.13 The hot-key menu allows you to set the hot key used to bring up the OSD.

H O T K E Y												
S E L E C T H O T K E Y :												
S	c	r	o	l	l	L	o	c	k			
N	u	m	b	e	r	L	o	c	k			
C	a	p	s	L	o	c	k					
L	e	f	t	C	t	r	l					
R	i	g	h	t	C	t	r	l				
L	e	f	t	A	l	t						
R	i	g	h	t	A	l	t					
L	e	f	t	W	i	n						
R	i	g	h	t	W	i	n					



4.14 The time settings menu allows you to set the auto-scan time for host port by port.



4.15 The OSD mouse menu allows you to set the OSD cursor mouse speed.



## 5.0 KVM Hot Key Operation (BHK117-8(16)Ue/BHK119-8(16)Ue Model Only)

- 5.1 Hot key can be provides convenient short cut to access functions similar to the OSD menu. You can have a full command of the KVM switch through a simple sequence of key. To access, you must press the **hotkey** (default **Caps Lock**) **twice within 2 seconds**. You will hear a beep sound confirming activation, then pressing another command key to submit. If you do not press any command key 2 second afterward it will escape back to normal mode.

Command	Function
Space bar	Bring up the OSD overlay screen
f or j	Moving Up or Down
[1,2,..,8] bank, [01, 02,.. J2] port	<ul style="list-style-type: none"> <li>■ The first digit is bank number starting with "1". The first KVM switch unit on the Daisy chain line is of bank 1 (the Master). A standalone KVM switch is fixed in bank 1.</li> <li>■ The second &amp; third digits are port number starting with "01".</li> </ul>
PgUp	Previous bank
PgDn	Next bank:
B	To enable/disable <b>beep sound</b> function
L	To enable,'disable the Screen <b>Saving</b> function and IOmin auto-logout function. This function is <b>default OFF (Disable)</b> .
P	To <b>log out the OSD</b> . If Security is enabled it will show up the Login window waiting for useaname and password. If Security is disabled it will show up the Stams window
R	For SUPERVISOR to set the OSD back to <b>factoiy default value</b> (except User Security settings).
S	For SUPERVISOR to activate the <b>Auto-Scan</b> function
i;	For SUPERVISOR to enable/disable <b>Security</b> function. If the Security is off, we don't need user name & password to access to the KVM system. This function is <b>default OFF (Disable)</b> .

- 5.2 Alternately, you can manually directly change the port by selecting the pre-assign port button located on the surface of the keyboard as well.



## 6.0 Screen Display Adjustment

- 6.1 Press the control button to setup screen brightness/contrast and other adjustments for display accordingly.



- 6.2 Adjust LCD OSD to match the display to your video board via the OSD button located on right side of the LCD panel. Press the MENU button to bring the on screen menu out and then follow instructions. Press the UP/DOWN button to scroll through the menu and press the SELECT button to enter the selected item. And UP/DOWN button to adjust value as necessary.



## 7.0 Standard Accessory Kits

Package Content		Description	Qty
1	User's Manual	User's Reference Guide	1
2	ESD Bag	ESD Bag for additional packaging	1
3	110 Power Cord 220 Power Cord (Option)	110 Power Cord 220 Power Cord (Option)	1
4	Screw Pack	Screws/Clips	1
5	Bracket	Extension Support Bracket	2
6	SMK 9XX	LCD Keyboard Drawer	1
7	KVM Cable	KVM Host Cable (PS/2 or USB)	1/8/16
8	Package	Foam with Box	1

