



JC-102A/104A
2/4 Port Keyboard, Video, and Mouse
KVM Switch With Audio

USER MANUAL



Add: 2283 Paragon Dr. San Jose, Ca. 95131
Free Phone: 1-888-778-3383
Tel: 408-392-9998 Fax: 408-392-9929
Email: support@justcomtech.com
sales@justcomtech.com
URL: www.justcomtech.com

TABLE OF CONTENTS

INTRODUCTION.....	1
PRODUCT FEATURES.....	1
SPECIFICATIONS.....	2
PACKAGE CONTENTS.....	2
FRONT AND BACK VIEWS.....	3
SYSTEM REQUIREMENTS.....	4
BASIC INSTALLATION.....	5
USING THE JC-102A/104A.....	8
HOT-KEY COMMANDS.....	9

JC-102A/104A

Introduction

Thank you for purchasing the JC-102A/104A KVM Switch. You can accurately control 2/4 computer systems through a single console (keyboard, monitor and mouse). The JC-102A/104A supports several kinds of mice including the wheel mice. It also supports high video resolution up to 2048 x 1536 without any deterioration of the image quality. There are two ways for computer selection: through Hot- Key commands from the keyboard or using the front-panel "select push-button".

Product Features

- Engineered and designed to be positioned in a vertical or horizontal position.
- HDDB 26 pin All-in-one connector.
- Control 2/4 computers from one console.
- Built-in microphone and speaker jacks for multimedia environment.
- Windows 95, 98, 2000, ME, NT, XP, Linux Red hat 7.3, free BSD support.
- No drivers or other additional software needed.
- Keyboard and mouse emulation allows error-free booting.
- The status of the CAPS LOCK, SCROLL LOCK, and NUM LOCK keys are stored for each of the computers.
- Superior video quality up to 2048 x 1536 @ 85MHz.
- Supports VGA, SVGA and Multi-Sync monitors.
- All metal construction.
- Offers Hot-key switching or select push button.
- Auto Scan mode for easy automatic switching.
- Front panel status LEDs give a clear indication of the active PC.
- Audible beeps feedback when switching between computers.

JC-102A/104A

Specifications

Length:	118.6mm(JC-102A), 160 mm(JC-104A)
Width:	96/96 mm
Height:	43/43 mm

Operation and Storage parameters

Operating Temperature: 0~40°C (32~104°F)

Storage Temperature: -20~60°C (-4~140°F)

Humidity: 0~80% RH non-condensing

PC port connections

5-in-1 HDDB 26 pin (keyboard, mouse, VGA),
Audio, Microphone (Female x 2 or 4, depending on your model)

Console connections

Keyboard: Mini DIN 6 pin Female
Mouse: Mini DIN 6 pin Female
Monitor: HDDB 15 pin Female
Audio: Mic & Speaker jacks

Package Contents

Item	Qty
JC-102A /104A	1 x KVM Switch With Audio
5-in-1 Cable Set 4' and 6'	2 or 4 (1 or 2 cables each length, depending on your model)
Power Adapter	1 (DC9V, 600mA)
Stand	1
User Manual	1

JC-102A/104A

Front And Back Views

Front View

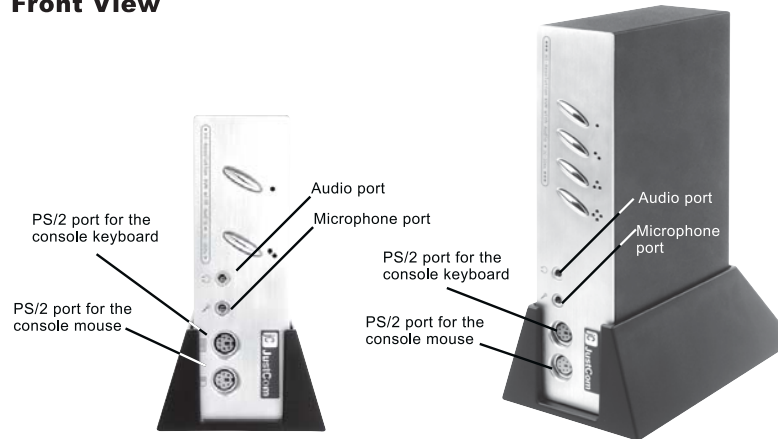

Back View

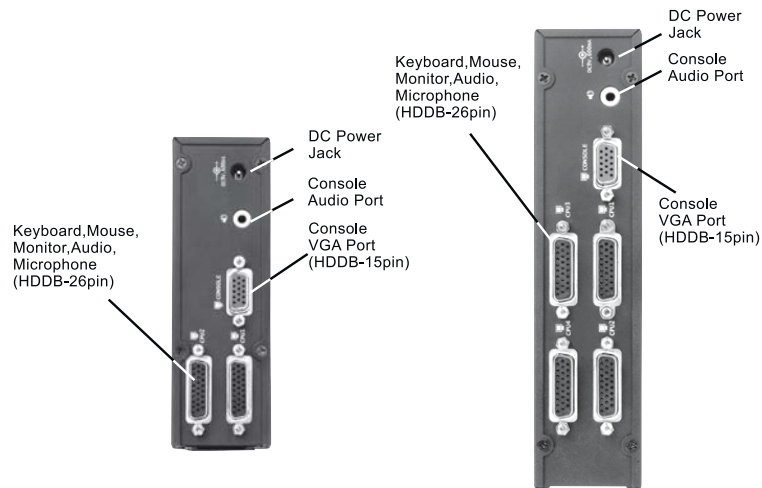

JC-102A/104A

System Requirements

Computers with PS/2 mouse connections, PS/2 or AT* keyboard connections, and HDDB 15 VGA connection.

IMPORTANT : Serial mice are not supported, and AT keyboards require an AT to PS/2 adapter.

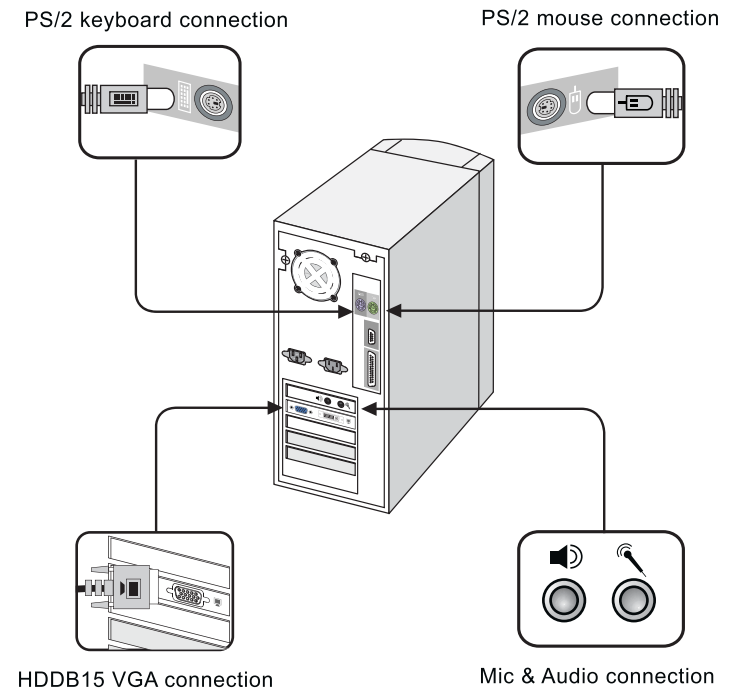

JC-102A/104A

Basic Installation



Before you begin, make sure that the power to your computers and all the devices you are planning to use is powered off.

NOTE: To prevent damage to your installation due to ground potential difference, make sure that all devices on the installation are properly grounded. JustCom Corporation will not be responsible for damaged caused in this way.

Connecting the Console

1. Connect the male VGA connector (HDDB-15 pin) from your monitor to the console VGA port on the back of the Switch.

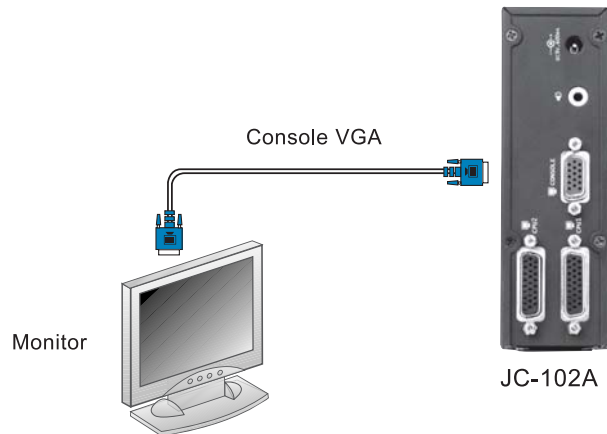

JC-102A/104A

Basic Installation

2. Connect your PS/2 keyboard and mouse into the PS/2 keyboard and mouse ports on the front panel of your switch.

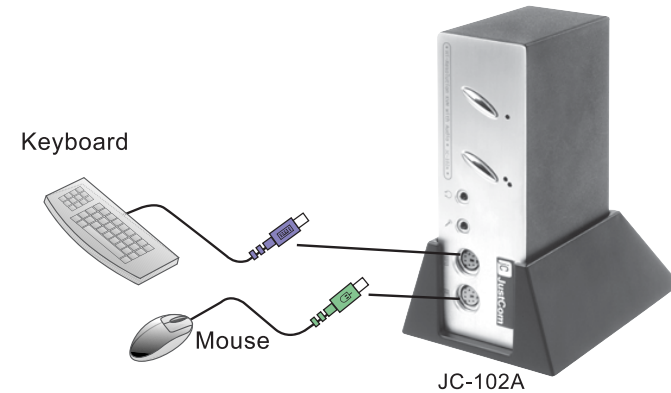

3. Connect your Audio and Microphone to the front panel of the JC-102A/104A.

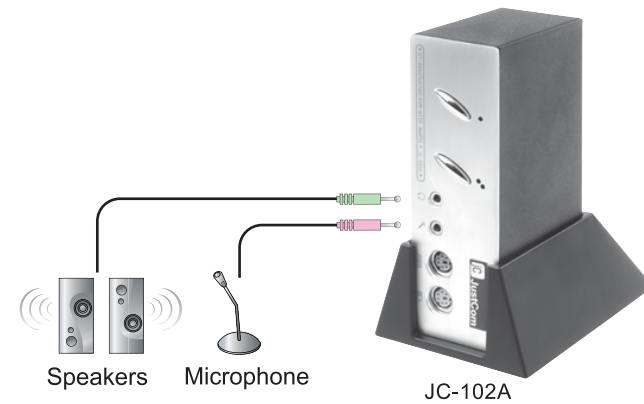

Basic Installation**Connecting your Computers**

4. Now, use JustCom 5-in-1 cable (included in the package) to connect the PC. (The 5-in-1 cable consists of Keyboard / Mouse / VGA / Microphone / speaker). Connect this cable (Male) to the PC1 port on the rear panel. Repeat this step for all PCs. (See the figure below)

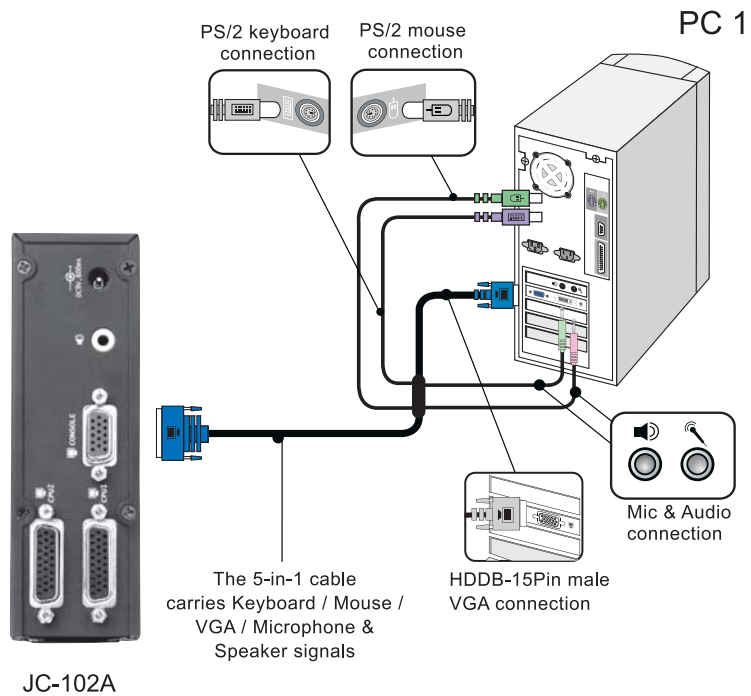
**Using the JC-102A/104A****Operation**

Controlling your computers with the JC-102A/104A couldn't be easier. The JC-102A/104A allows you to access the computers and Audio channels by using simple Hot-key combinations from the keyboard.

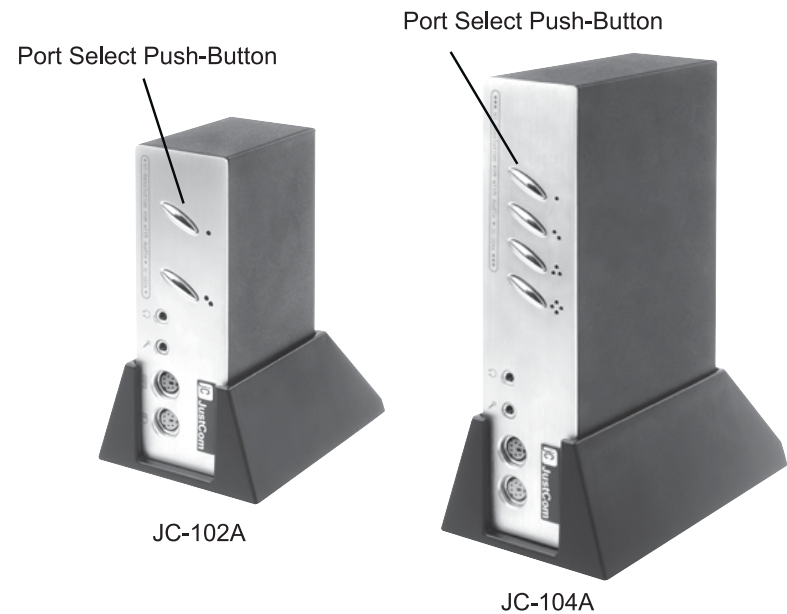

Hot Key Commands On Keyboard

Selecting Computers

You can change ports through simple Hot-key commands from the keyboard by using the "SCROLL LOCK" key and UP and DOWN arrow keys.

1. To enter the Hot-key mode, press the "SCROLL LOCK" key twice within two seconds.
2. Press the UP or DOWN arrow keys to switch to the previous or next port respectively.

Alternatively you can directly switch the KVM focus to any computer by entering the switch port number. Each computer is assigned a numeric ID. For example, if you press [SCROLL LOCK] + [SCROLL LOCK] + "2", the computer on port 2 will be selected. (See the figure below)

First key sequence	Combination keys	Funtion
ScrollLock	ScrollLock	↓ Switch to Next PC
ScrollLock	ScrollLock	↑ Switch to Previous PC
ScrollLock	ScrollLock	0 Go to Auto-Scan Mode
ScrollLock	ScrollLock	S Turn off Buzzer Sound
ScrollLock	ScrollLock	P + X (X=1,2,3,4) Go to Channel only
ScrollLock	ScrollLock	V + X (X=1,2,3,4) Change Audio port only
ScrollLock	ScrollLock	A + X (X=1,2,3,4) Change Channel with Audio
ScrollLock	ScrollLock	F1 (for 3 sec) F2 (for 5 sec) F3 (for 7 sec) Change Scan Mode time
Space Bar		Stop Auto Scan Mode

Hot Key Commands On Keyboard

Switching Audio Separately

Sometimes you may wish to hear the audio from one of your computers while using the other, for instance, when playing a CD or any Audio file on one PC while working on the second one. This eliminates the hassle of having to unplug and re-plug your speakers or microphone.

To switch Audios, but leave the PCs channel unchanged:

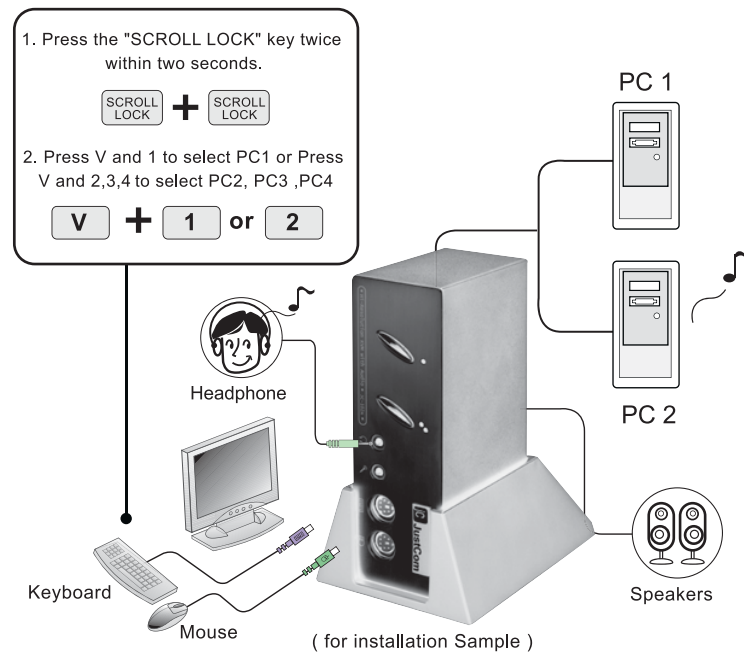

To resume normal (combined KVM and Audio) operation:

Select a computer in the normal manner by using Hot-Key commands from the keyboard (see "Selecting Computers" Hot-Key commands on page 9).

Hot Key Commands On Keyboard**Auto Scan Mode**

The Auto Scan feature allows you to monitor the activity of the connected computers at regular 10 second intervals so that you can monitor the computers activity without having to switch. (Note: This time interval cannot be changed.)

To invoke Auto Scan Mode, press [SCROLL LOCK] + [SCROLL LOCK] + "0".

NOTE:

1. The interval between these two keys should be no more than 1.5 seconds. Once the scanning begins, it continues until you press the [Space Bar] to exit the Auto Scan Mode.
2. While the Auto Scan Mode is in effect, the keyboard and mouse will be DISABLED except for the [Space Bar] key. To exit the Auto Scan Mode, press the [Space Bar].

FCC Certifications

This equipment has been tested and found to comply with the limits for a Class B digital device, pursuant to Part 15 of the FCC Rules. These limits are designed to provide reasonable protection against harmful interference in a residential installation. This equipment generates uses and can radiate radio frequency energy and, if not installed and used in accordance with the instructions, may cause harmful interference to radio communications. However, there is no guarantee that interference will not occur in a particular installation. If this equipment does cause harmful interference to radio or television reception, which can be determined by turning the equipment off and on, the user is encouraged to try to correct the interference by one or more of the following measures:

- * Reorient or relocate the receiving antenna.
- * Increase the separation between the equipment and receiver.
- * Connect the equipment into an outlet on a circuit different from that to which the receiver is connected.
- * Consult the dealer or an experienced radio/TV technician for help.
- * Shielded interface cables must be used in order to comply with emission limits.
- * You are cautioned that changes or modifications not expressly approved by the party responsible for compliance could void your authority to operate the equipment.
- * This device complies with Part 15 of the FCC rules. Operation is subject to the following two conditions: (1) This device may not cause harmful interference, and (2) This device must accept any interference received, including interference that may cause undesired operation

CE Mark Warning

This is a Class B product. In a domestic environment, this product may cause radio interference, in which case the user may be required to take adequate measures.

GOVERNING LAW:

This Limited Warranty shall be governed by the laws of the state of California.

Some states do not allow exclusion or limitation of incidental or consequential damages, or limitations on how long an implied warranty lasts, so the foregoing limitations and exclusions may not apply. This limited warranty provides specific legal rights and the product owner may also have other rights which vary from state to state.

Trademarks

Copyright 2003 JustCom Technology Inc. Contents subject to change without prior notice. JustCom is a registered trademark of JustCom Technology Inc. All other trademarks belong to their respective proprietors.

Copyright Statement

No part of this publication may be reproduced in any form or by any means or used to make any derivative such as translation, transformation, or adaptation without permission from JUSTCOM Technology Inc, as stipulated by the United States Copyright Act of 2003.

Registration Card

Print, type or use block letters.

Your name: Mr./Ms _____
 Organization: _____ Dept. _____
 Your title at organization: _____
 Telephone: _____ Fax: _____
 Organization's full address: _____
 Country: _____
 Date of purchase (Month/Day/Year): _____

Product Model	Product Serial Number	* Product installed in type of Computer (E.g., Compaq(486))	* Product installed Incomputer serial

(* Applies to adapters only)

Product was purchased from:

Reseller's name: _____
 Telephone: _____ Fax: _____
 Reseller's full address: _____

Answers to the following questions help us to support your product:

- Where and how will the product primarily be used?**
 Home Office Travel Company Business Home Business Personal Use
- How many employees work at installation site?**
 1 employee 2-9 10-49 50-99 100-499 500-999 1000 or more
- What network protocol(s) does your organization use ?**
 XNS/IPX TCP/IP DECnet Others _____
- What network operating system(s) does your organization use ?**
 Justcom LANsmart Novell NetWare NetWare Lite SCO Unix/Xenix PC NFS 3Com 3+Open
 Banyan Vines DECnet Pathwork Windows NT Windows NTAS Windows '95
 Others _____
- What network management program does your organization use ?**
 D-View HP OpenView/Windows HP OpenView/Unix SunNet Manager Novell
 NMS NetView 6000 Others _____
- What network medium/media does your organization use ?**
 Fiber-optics Thick coax Ethernet Thin coax Ethernet 10BASE-T UTP/STP
 100BASE-TX 100BASE-T4 100VGAnyLAN Others _____
- What applications are used on your network?**
 Desktop publishing Spreadsheet Word processing CAD/CAM
 Database management Accounting Others _____
- What category best describes your company?**
 Aerospace Engineering Education Finance Hospital Legal Insurance/Real
 Estate Manufacturing Retail/Chainstore/Wholesale Government
 Transportation/Utilities/Communication VAR System house/company
 Other _____
- Would you recommend your Justcom product to a friend?**
 Yes No Don't know yet
- Your comments on this product?**
