

Dedicated KVM switch and rackmount screen technology

## User Manual

**NV801A**

**PS/2 DB-15 KVM**

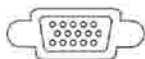

i-Tech Company LLC

TOLL FREE: (888) 483-2418 • EMAIL: [info@iTechLCD.com](mailto:info@iTechLCD.com) • WEB: [www.iTechLCD.com](http://www.iTechLCD.com)

## Legal Information

First English printing, October 2002

Information in this document has been carefully checked for accuracy; however, no guarantee is given to the correctness of the contents. The information in this document is subject to change without notice. We are not liable for any injury or loss that results from the use of this equipment.

## Safety Instructions

**Please read all of these instructions carefully before you use the device. Save this manual for future reference.**

- Unplug equipment before cleaning. Don't use liquid or spray detergent; use a moist cloth.
- Keep equipment away from excessive humidity and heat. Preferably, keep it in an air-conditioned environment with temperatures not exceeding 40° Celsius (104° Fahrenheit).
- When installing, place the equipment on a sturdy, level surface to prevent it from accidentally falling and causing damage to other equipment or injury to persons nearby.
- When the equipment is in an open position, do not cover, block or in any way obstruct the gap between it and the power supply. Proper air convection is necessary to keep it from overheating.
- Arrange the equipment's power cord in such a way that others won't trip or fall over it.
- If you are using a power cord that didn't ship with the equipment, ensure that it is rated for the voltage and current labeled on the equipment's electrical ratings label. The voltage rating on the cord should be higher than the one listed on the equipment's ratings label.
- Observe all precautions and warnings attached to the equipment.
- If you don't intend on using the equipment for a long time, disconnect it from the power outlet to prevent being damaged by transient over-voltage.
- Keep all liquids away from the equipment to minimize the risk of accidental spillage. Liquid spilled on to the power supply or on other hardware may cause damage, fire or electrical shock.
- Only qualified service personnel should open the chassis. Opening it yourself could damage the equipment and invalidate its warranty.
- If any part of the equipment becomes damaged or stops functioning, have it checked by qualified service personnel.

## What the warranty does not cover

- Any product, on which the serial number has been defaced, modified or removed.
- Damage, deterioration or malfunction resulting from:
  - Accident, misuse, neglect, fire, water, lightning, or other acts of nature, unauthorized product modification, or failure to follow instructions supplied with the product.
  - Repair or attempted repair by anyone not authorized by us.
  - Any damage of the product due to shipment.
  - Removal or installation of the product.
  - Causes external to the product, such as electric power fluctuation or failure.
  - Use of supplies or parts not meeting our specifications.
  - Normal wear and tear.
  - Any other causes which does not relate to a product defect.
- Removal, installation, and set-up service charges.

## Regulatory Notices Federal Communications Commission (FCC)

This equipment has been tested and found to comply with the limits for a Class B digital device, pursuant to Part 15 of the FCC rules. These limits are designed to provide reasonable protection against harmful interference in a residential installation.

Any changes or modifications made to this equipment may void the user's authority to operate this equipment. This equipment generates, uses, and can radiate radio frequency energy and, if not installed and used in accordance with the instructions, may cause harmful interference to radio communications.

However, there is no guarantee that interference will not occur in a particular installation. If this equipment does cause harmful interference to radio or television reception, which can be determined by turning the equipment off and on, the user is encouraged to try to correct the interference by one or more of the following measures:

- Re-position or relocate the receiving antenna.
- Increase the separation between the equipment and receiver.
- Connect the equipment into an outlet on a circuit different from that to which the receiver is connected.

# Contents

## < Part 1 > PS/2 DB-15 KVM

NV801A

1.1	Package contents	P.1
1.2	KVM port connection	P.1
1.3	KVM Cascade	P.2
1.4	Specifications	P.3

## < Part 2 > Usage

2.1	KVM Button	P.4
2.2	Password	P.5
2.3	KVM OSD	P.6
2.4	KVM Hotkey	P.7
2.5	DC power 12V, 24V, 48V Input	P.8

## Before Installation

- It is very important to mount the equipment in a suitable cabinet or on a stable surface.
- Make sure the place has a good ventilation, is out of direct sunlight, away from sources of excessive dust, dirt, heat, water, moisture and vibration.

## Unpacking

The equipment comes with the standard parts shown in package content. Check and make sure they are included and in good condition. If anything is missing, or damaged, contact the supplier immediately.

## Installation for standalone KVM

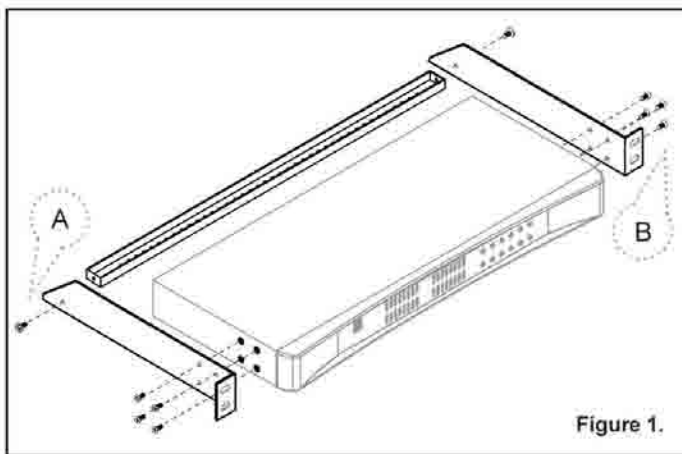

Screw A: 2 pcs



M3.2 x 4.5 mm

Screw B: 8 pcs



M4 x 10 mm

- Install each bracket using screws provided shown in **Figure 1**.

- Fix the KVM into the rack

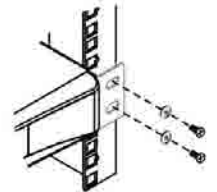

**Part 1. PS/2 DB-15 KVM**  
**< 1.1 > Package Contents**

**PS/2 DB-15 KVM**

**NV801A**

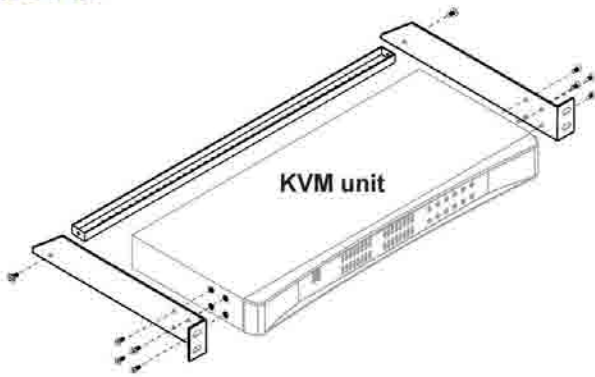

- NV801A KVM unit x 1
- Mounting set w/ bracket & screws x 1
- Power cord ( for KVM ) x 1

**NV801A**

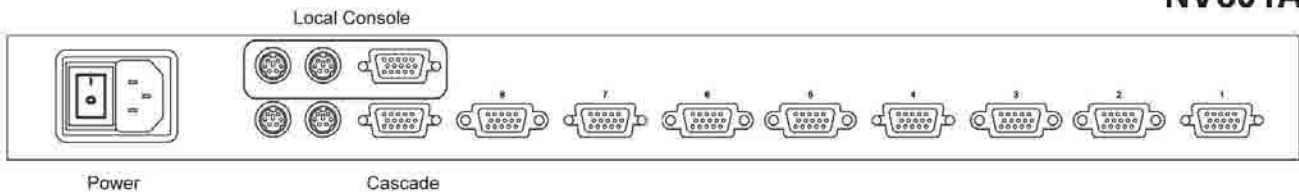

**< 1.2 > KVM port connection**

**CD-6 / CD-10 / CD-15**

- 6 / 10 / 15 ft PS/2 KVM cable
- Support PS/2 server



**PS/2 Servers**

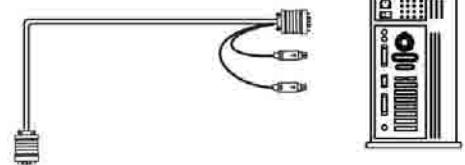

**DB-15 PS/2 KVM port**

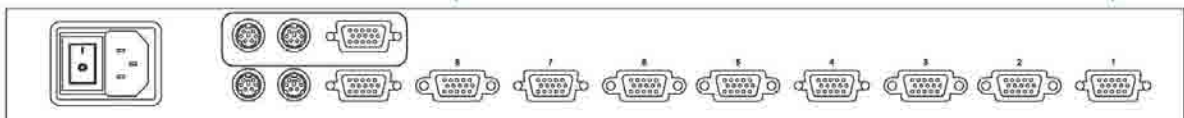

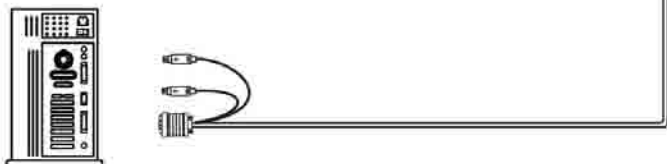

**PS/2 Servers**



## < 1.3 > KVM Cascade

- Cascade up to 8 levels, 64 servers
- Cascading multiple KVM with CA-6 cascade cable.

 Cascaded KVMs from level 2 to 8 must be the models of NV801A.

 When multiple PS/2 DB-15 KVMs cascade together, the master KVM at level 1 will take all control of other slave KVM switches (e.g. level 2 to 8).

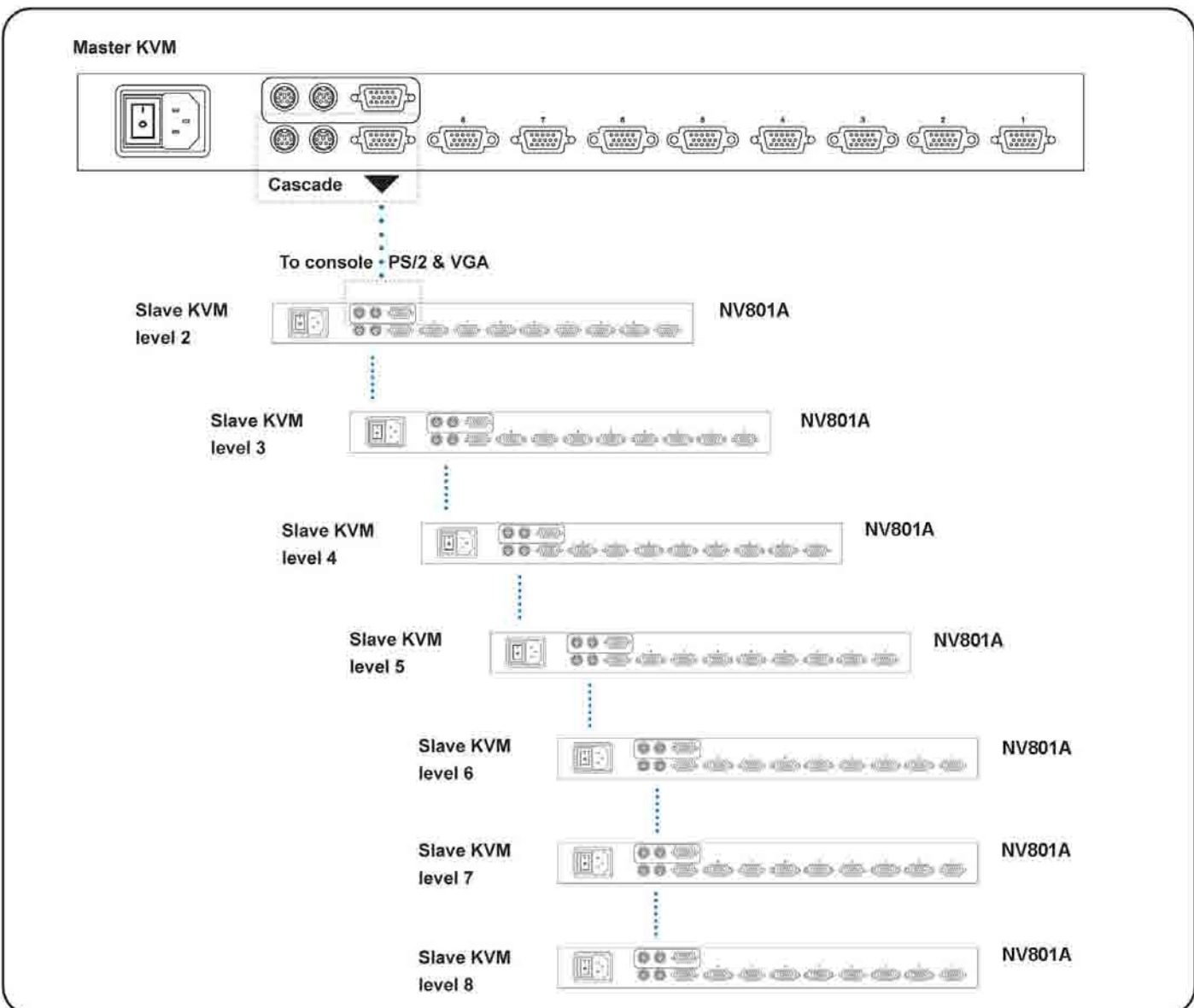

### NA-6

- 6ft PS/2 KVM cascade cable

<b>NV801A</b>	
<b>■ KVM Port</b>	
Number of ports:	8
Connector:	DB-15 combo connector
Connectivity:	PS/2 3-in-1 KVM cable, up to 6, 10 & 15 feet
<b>■ Local Console</b>	
Graphic connector:	1 x DB-15 VGA
Resolution:	Up to 1600 x 1200
Input device:	2 x PS/2 for keyboard & mouse
<b>■ Management</b>	
OSD:	English
Hotkey:	Scroll-lock
Security:	Password enable & disable
PC Selection:	Front button, OSD menu & hotkey
<b>■ Expansion:</b>	Up to 64 servers by 8-level cascade
<b>■ Compatibility</b>	
Multi-platform:	Mix PCs, SUN and Mac G3 / G4 Mac / iMac
Support:	Windows 7 / Vista / 2003 / XP, Linux, Unix
<b>■ Power</b>	
Input:	Auto sensing 100 to 240VAC, 50 / 60 Hz
Option DC:	12V / 24V / 48V DC input
Consumption:	Max. 12 Watt, Standby 5 Watt
<b>■ Regulatory</b>	
Safety:	FCC & CE certified
Environment:	RoHS2 & REACH compliant
<b>■ Environmental</b>	
Operating:	0 to 50°C
Storage:	-5 to 60°C
Relative humidity:	90%, non-condensing
Shock:	50G peak acceleration (11ms, half-sine wave)
Vibration:	58~100Hz / 0.98G (11ms / cycle)
<b>■ Product Information</b>	
Dimension (W x D x H):	443 x 171 x 44 mm / 17.4 x 6.7 x 1.73 inch
Net weight:	3 kg / 6.5 lb
<b>■ Packing Information</b>	
Dimension (W x D x H):	500 x 400 x 90 mm / 19.7 x 15.7 x 3.5 inch
Gross weight:	5 kg / 11 lb



## 2.1 KVM Button

### Power ON

- Turn off all servers and KVM switches
- Make sure all cables / connectors are properly connected
- Recommend Power ON sequence is monitor, KVM switch finally computer

### Front Panel - Port LED Indications

#### PS/2 DB-15 KVM 8 ports

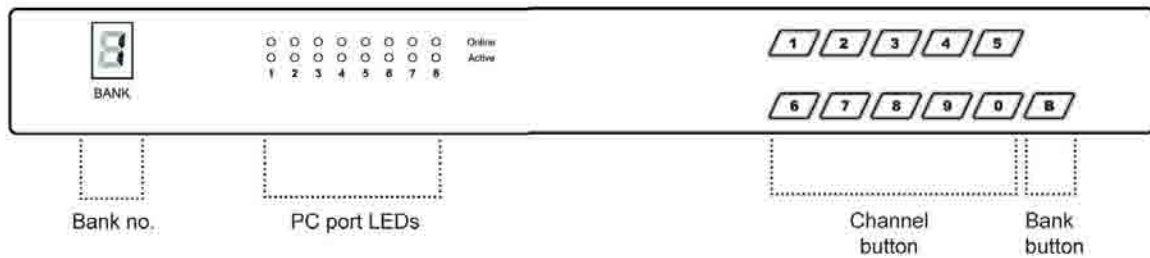

Bank no.	7-Segment BANK LED indication
PC port LEDs	<b>Online</b> : Blue LED on indicating a PC is connecting to the port <b>Active</b> : Green LED on indicating a selected channel
Channel button	Press to select channel from 01 to 08



The password is enabled by default, the default password is "00000000" eight zeros (**Do not use "0" on number pad**)

### ■ Set your own user name & password

1. Call KVM OSD menu by pressing the KVM hotkey **Scroll Lock + Scroll Lock + Space Bar**
2. Select "CHANGE PASSWORD"
3. Enter "00000000" eight zeros in password field  
**(Do not use "0" on number pad)**
4. Set your own password in "ENTER NEW PASSWORD" field
5. Retype your own new password in "RETYPE NEW PASSWORD" field

Remark: a. Blank has underscore. SPACE does not have underscore.  
b. Press any alphanumeric key to move to next input item.

### ■ Change your password

1. Call KVM OSD menu by pressing the KVM hotkey **Scroll Lock + Scroll Lock + Space Bar**
2. Select "CHANGE PASSWORD"
3. Enter your own password
4. Change your password in "ENTER NEW PASSWORD" field
5. Retype your new password in "RETYPE NEW PASSWORD" field

Remark: a. Blank has underscore. SPACE does not have underscore.  
b. Press any alphanumeric key to move to next input item.

### ■ Forget your password

Please contact your supplier for further support



Remark:

- You must press the KVM hotkey within 2 seconds
- A beep sound will be heard for successful entering KVM hotkey

**OSD Menu**

BANK : 1					
01	☀	SYSTEM	01	☞	02 SYSTEM 02
03		SYSTEM	03		04 SYSTEM 04
05		SYSTEM	05		06 SYSTEM 06
07		SYSTEM	07		08 SYSTEM 08
OSD : 10 SEC		CHANGE PASSWORD			
SCAN : 10 SEC		CONSOLE ON OFF			
ESC : QUIT		ENTER : COMPLETE			
TAB : NEXT		INSERT : EDIT			
↑/↓ : PORT SELECT					
PgUp/PgDn : BANK SELECT					

**OSD operation**

 next to the system name	The PC is powered on
 next to the system name	The PC is selected
OSD	OSD menu on screen time
SCAN	Scan interval from one PC port to next PC when applying auto scan
CHANGE PASSWORD	Change to a new password
Console ON/OFF	ON - quit the OSD menu without password OFF - password is requested while quitting the OSD menu
ESC	QUIT
TAB	NEXT
↑/↓	Select port for destination PC name and press "Enter" to select
PgUp / PgDn	To switch previous or next bank
ENTER	Complete
INSERT	Edit

Hotkey	Function
Scroll Lock + Scroll Lock + Space Bar	Calling OSD menu
Scroll Lock + Scroll Lock + ↑	Switch to previous port
Scroll Lock + Scroll Lock + ↓	Switch to next port
Scroll Lock + Scroll Lock + PgUp	Switch to previous bank
Scroll Lock + Scroll Lock + Bank no. + Port no.	Switch to specific port
Scroll Lock + Scroll Lock + PgDn	Switch to next bank
Scroll Lock + Scroll Lock + S	Auto scan for powered on PC
Scroll Lock + Scroll Lock + R	Reset to factory default setting
Scroll Lock + Scroll Lock + B	Enable / Disable beeper sound
Scroll Lock + Scroll Lock + F	Find port by name

**Remarks:**

Example of "Scroll Lock + Scroll Lock + Bank no. + Port no."

- Bank No. : 1 to 8
- Port No. : 01 to 08
- e.g. Bank 1 Port 04 : Scroll Lock + Scroll Lock + 1 + 0 + 4
- e.g. Bank 2 Port 08 : Scroll Lock + Scroll Lock + 2 + 0 + 8

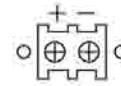
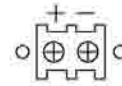
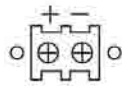

Model	12V	24V	48V
<b>Input rating</b>			
Input voltage:	12-Volt	24-Volt	48-Volt
Input range:	9 ~ 18V	18 ~ 36V	36 ~ 75V
Input current:			
- No load	50 mA	50 mA	50 mA
- Full load	4950 mA	2450 mA	1220 mA
<b>Output rating</b>			
Output voltage:	12-Volt	12-Volt	12-Volt
Output current:	4.16A	4.16A	4.16A
<b>Efficiency</b>	84%	85%	85%

**Remarks:**

- Package does not include power cord