

User's Guide

Durable Series

Models DS1000B,2000B,3000B

DS1000B-RM, DS2000B-RM, DS3000B-RM

LIMITED WARRANTY

For your records

The serial number of your UPS is on the rear panel. You should note the serial number in the space provided below. Retain this booklet as a permanent record of your purchase to aid in identification in the event of theft or loss.

Model No:

Serial No.:

Purchase Date:

What the warranty covers:

We warrant this product to be free from defects in material and workmanship during the warranty period. If a product proves to be defective in material or workmanship during the warranty period, we will at our sole option repair or replace the product with a like product.

How long the warranty is effective:

For accurate warranty period and conditions, please contact local branch offices or your dealers.

Who the warranty protects:

This warranty is valid only for the first consumer purchaser.

What the warranty does not cover:

1. Any product on which the serial number has been defaced, modified or removed.
2. Damage, deterioration or malfunction resulting from:
 - a) Accident, misuse, neglect, fire, water, or other acts of nature, unauthorized product modification, or failure to follow instructions supplied with the product.
 - b) Repair or attempted repair by anyone not authorized.
 - c) The fault is result of accidental damage or damage in transit or transportation, including but not limited to liquid spillage.
 - d) Removal or installation of the product.
 - e) Causes external to the product.
 - f) Use of supplies or parts not meeting our specifications.
 - g) Normal wear and tear.
 - h) Any other cause which does not relate to a product defect.
3. Removal, installation and set-up service charges.

Opti Australia reserves the right to request proof of purchase upon any warranty claim.

Limitation of implied warranties:

THERE ARE NO WARRANTIES, EXPRESS OR IMPLIED, WHICH EXTEND BEYOND THE DESCRIPTION CONTAINED HEREIN INCLUDING THE IMPLIED WARRANTY OF MERCHANTABILITY AND FITNESS FOR A PARTICULAR PURPOSE.

Exclusion of damages:

OUR LIABILITY IS LIMITED TO THE COST OF REPAIR OR REPLACEMENT OF THE PRODUCT. WE SHALL NOT BE LIABLE FOR:

1. DAMAGE TO OTHER PROPERTY CAUSED BY ANY DEFECTS IN THE PRODUCT*, DAMAGES BASED UPON INCONVENIENCE, LOSS OF USE OF THE PRODUCT, LOSS OF TIME, LOSS OF PROFITS, LOSS OF BUSINESS OPPORTUNITY, LOSS OF GOODWILL, LOSS OF DATA, LOSS OF SOFTWARE, COSTS OF SUBSTITUTE EQUIPMENT, INTERFERENCE WITH BUSINESS RELATIONSHIPS, CLAIMS BY THIRD PARTIES, OR OTHER COMMERCIAL LOSS, EVEN IF ADVISED OF THE POSSIBILITY OF SUCH DAMAGES.
2. ANY OTHER DAMAGES, WHETHER INCIDENTAL, CONSEQUENTIAL OR OTHERWISE.
3. ANY CLAIM AGAINST THE CUSTOMER BY ANY OTHER PARTY.

Effect of state law (for US):

This warranty gives you specific legal rights, and you may also have other rights which vary from state to state. Some states do not allow limitations on implied warranties and/or do not allow the exclusion of incidental or consequential damages, so the above limitations and exclusions may not apply to you.

Limitations of Warranty (for Australian States and Territories)

The Trade Practices Act 1974 and corresponding State and Territory Fair Trading Acts or legalization of another Government (“the relevant acts”) in certain circumstances imply mandatory conditions and warranties which cannot be excluded. This warranty is in addition to and not in replacement for such conditions and warranties. To the extent permitted by the Relevant Acts, in relation to your product and any other materials provided with the product (“the Goods”) the liability of Opti Australia under the Relevant Acts is limited, at the option of Opti Australia to:

- Replacement of the Goods; or
- Repair of the Goods; or
- Payment of the cost of replacing the Goods; or
- Payment of the cost of having the Goods repaired.

Life Support:

We do not recommend the use of our UPS products for life support equipment or direct care where failure of a UPS product could cause failure of, or diminished effectiveness of the life support equipment or patient care.

*Except as expressly provided for by the UPS “Equipment Protection Policy”

EFFECTIVE October 1, 1997

EMC Statements

FCC Part 15

NOTICE: Pursuant to section 15 of the FCC rules, this product has been tested and thereby complies to the conditions of a Class B (1000VA-2000VA) and Class A (3000VA) digital device, which have been established for offering sufficient protection against dangerous interference for installation in a residential area. Installation and use of the equipment should comply with the instructions provided in order to avoid such interference due to the amount of radio frequency energy that is radiated and generated by the equipment. In spite of this, we cannot assure that a certain amount of interference may not occur in some installations. If, by turning on and off, it can be deduced that your radio or television reception is found to be influenced by harmful interference from the equipment, it is recommended to use one of the following preventive measures:

- Place the receiving antenna in a separate location or orientation.
- Ensure a greater distance is achieved between the receiver and the equipment.
- Ensure that your equipment is connected to an outlet on a separate circuit than the receiver.
- Contact a technician experienced with radio and TV or a dealer for further assistance.

ICES-003

This Class B Interference Causing Equipment meets all requirements of the Canadian Interference Causing Equipment Regulations ICES-003. Cet appareil numérique de la classe B respecte toutes les exigences du Règlement sur le matériel brouilleur du Canada.

Declaration of Conformity Request

Units labeled with a CE mark comply with the following standards and directives:

- Harmonic Standards: EN 50091-1-1 and EN 50091-2
- EU Directives: 73/23/EEC, Council Directive on equipment designed for use within certain voltage limits
93/68/EEC, Amending Directive 73/23/EEC
89/336/EEC, Council Directive relating to electromagnetic compatibility
92/31/EEC, Amending Directive 89/336/EEC relating to EMC

The EC Declaration of Conformity is available upon request for products with a CE mark.

TABLE OF CONTENTS

1. Introduction	3
2. System description	3
2.1 General description	3
2.2 System Configuration	5
3. Safety Information	6
4. Storage	7
5. Installation	7
5.1 Environment	7
5.2 Rear panel views	10
5.3 Connection to mains and loads (1000 - 3000 VA)	14
5.4 Default settings at the factory	15
6. Computer and Alarm connections	16
6.1 EPO port (emergency power off)	17
6.2 Data Line protection (1000 - 3000 VA)	17
6.2 Load segments (1000 - 3000 VA)	17
7. User's guide to operations	18
7.1 Starting and shutting down the UPS	18
7.2 Button Operation	18
7.3 Control Panel functions	19
7.4 Interpreting UPS messages	23
7.5 Trouble shooting	24
8. Maintenance	25
8.1 Replacing batteries	25
9. Warranty	27
10. Technical Specifications	27
10.1 Power Range 1000-3000 VA (100/110/120V)	27
10.2 Power Range 1000-3000 VA (220/230/240V)	27
10.3 Power Range 1000-3000 VA (100/110/120V 19" Rack-mount model)	28
10.4 Power Range 1000-3000 VA (220/230/240V 19" Rack-mount model)	29
10.5 Battery Packs	32

IMPORTANT SAFETY INSTRUCTIONS

SAVE THESE INSTRUCTION

- **CAUTION (UPS Having Internal Batteries):** Risk of electric shock - Hazardous live parts inside this unit are energized from the battery supply even when the input AC power is disconnected.
- **CAUTION (No User serviceable Parts):** Risk of electric shock, do not remove cover. No user serviceable parts inside. Refer servicing to qualified service personnel.
- **CAUTION (Non-isolated Battery supply):** Risk of electric shock, battery circuit is not isolated from AC input, hazardous voltage may exist between battery terminals and ground. Test before touching.
- **WARNING (Fuses):** To reduce the risk of fire, replace only with the same type and rating of fuse.
- **WARNING:** Intend for installation in a controlled environment.
- **CAUTION:** Do not dispose of batteries in a fire, the battery may explode.
- **CAUTION:** Do not open or mutilate the battery, released electrolyte is harmful to the skin and eyes.
- **CAUTION:** A battery can present a risk of electric shock and high short circuit current. The following precaution should be observed when working on batteries

Remove watches, rings or other metal objects.

Use tools with insulated handles.
- To reduce the risk of electric shock, disconnect the UPS from the mains supply before installing a computer interface signal cable. Reconnect the powers cord only after signaling interconnections have been made.
- Servicing of batteries should be performed or supervised by personnel knowledge of batteries and the required precautions. Keep unauthorized personnel away from batteries.

The instructions contained within this safety manual are deemed important and should be closely followed at all times during installation and follow-up maintenance of the UPS and batteries.



CAUTION

The unit has a dangerous amount of voltage. If the UPS indicator is on, the unit's outlets may have a dangerous amount of voltage even when not plugged into the wall outlet because the battery may continue to supply power.

Care should be taken to undertake installation indoors free from electrically-conductive particles which is under temperature and humidity control in order to reduce the risk of electric shock.

It is best to disconnect the device using the power supply cord. Ensure that the equipment is placed in a position near the outlet where easily accessible.

Except replacing the batteries, all servicing on this equipment must be carried out by qualified service personnel.

Before conducting any maintenance, repair or shipment, first ensure that everything is turned off completely and disconnected.

For additional safety instructions, please use the Safety Manual as reference.

Special Symbols

The following symbols used on the UPS warn you of precautions:



RISK OF ELECTRIC SHOCK – Please observe the warning that a risk of electric shock is present.



CAUTION: REFER TO OPERATOR'S MANUAL - Refer to the operator's manual for additional information, such as important operating and maintenance instructions.



SAFE GROUNDING TERMINAL - Indicates primary safe ground



LOAD ON/OFF - Pressing this button turns on/off the output receptacles and the Indicator light.



Please do not discard the UPS or UPS batteries as the UPS may have valve regulated, lead-acid batteries. Please recycle batteries.

1. Introduction

The information provided in this manual covers single phase 1000 – 3000 VA, uninterruptible power systems, their basic functions, operating procedures, and emergency situations, also including information on how to ship, store, handle and install the equipment. Only detailed requirements of the UPS units are described herein, and installation must be carried out in accordance with this manual. Electrical installations must also carefully follow local legislation and regulations. Only qualified personnel should conduct these installations as failure to acknowledge electrical hazards could prove to be fatal.

2. System description

Several different kinds of sensitive electrical equipment stay protected by a UPS (Uninterruptible Power System) including computers, workstations, process control systems, telecommunications systems, sales terminals, other critical instrumentation, etc. The purpose of the UPS is to protect these systems from poor quality utility power, complete loss of power, or other associated problems.

Electrical interference abounds in many forms causing problems in AC power, from lightning, power company accidents and radio transmissions to motors, air conditioners, and vending machines, among others. So protection of sensitive electrical equipment is vital to protect against power outages, low or high voltage, slow voltage fluctuations, frequency variations, differential and common-mode noises, transients, etc.

In order to prevent power line problems reaching critical systems causing damage to software, hardware and causing equipment to malfunction, the UPS helps by maintaining constant voltage, isolating critical load output if needed, and cleaning the utility AC power.

2.1 General description

As a double conversion on-line UPS, it is able to supply uninterrupted, clean single-phase power to your critical systems while keeping batteries charged continuously, regardless of whether utility power fails or not.

In event that a power failure lasts longer than a UPS backup time, it will shut down avoiding battery discharge, and as soon as voltage comes back, the UPS will automatically charge up and start recharging the batteries.

As shown in fig.1 block diagram:

- An input filter reduces transients on the mains
- For maintaining full battery charge, AC-power is rectified and regulated in the rectifier feeding power to the inverter and battery converter.

- DC power is converted to AC in the inverter passing it on to the load.
- Power is maintained from the battery during a power failure.
- The converter increases voltage appropriately for the inverter.

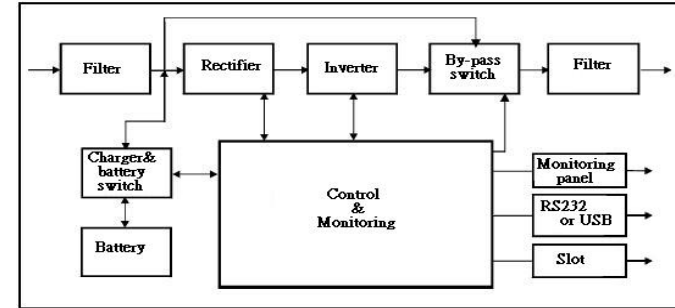

Fig.1. Block diagram

Efficiency Optimizer function

The Efficiency Optimizer function is a new feature for the UPS adding cost effectiveness, minimizing power loss and reducing power consumption. Alternating between bypass and on-line modes is achieved automatically and in accordance with the conditions of the utility power. On-line mode may be used during times of intermittent power supply, and bypass mode when power flows smoothly in order to obtain greatest efficiency. Irregularities can be detected in less than a second, and on-line mode reactivated immediately. Switching back to online mode occurs when input voltage is outside $\pm 10\%$ or nominal ($\pm 15\%$ selectable), when input frequency is outside of $\pm 3\text{Hz}$ or when no input line is available.

Although high efficiency is standard, the default operation is in on-line mode. Bypass can be activated in the LCD panel, though on-line can be run permanently if preferred.

Free Run Mode

The UPS operates in free run mode when input frequency is outside of the selected input frequency range. Free run mode is when output frequency does not match input frequency. When starting the UPS, the frequency regulation detected is 50 or 60 Hz $\pm 0.25\text{Hz}$. Please refer to chapter 7.2 if you want bypass available while running in free run mode.

Diagnostic tests

When you start the UPS, a diagnostic test is automatically executed that checks electronics, battery, and reports any problems on the LCD display.

An advanced battery management system always monitors the conditions of the batteries

sends any forewarnings if replacement is needed. Otherwise every 30 days of normal mode operation, a battery discharge test is performed and any problems reported on the LCD display.

Except during the first 24 hours after startup while the UPS is in charging mode (please see chapter 7.2), diagnostic tests can be performed manually from the front panel at any time.

2.2 System Configuration

The UPS device and the internal backup battery make up the system. Depending on the site and load requirements of the installation, certain additional options are available as a tailored solution.

Planning a UPS system, the following should be taken into consideration:

- The total demand of the protected system shall dictate the output power rating (VA). Allow a margin for future expansion or calculation inaccuracies from measuring power requirements.
- Backup time needed will indicate the battery size needed. If load is less than the UPS nominal power rating then actual backup time is longer.
- The following options are available:
 - External Battery Cabinets
 - Transformer cabinets
 - Maintenance bypass switches
 - Connectivity options (relay card, SNMP/WEB card)

The following UPS models are available

Model	Backup time (Full Load)	Recharge time to 90% capacity
	Internal batteries	
UPS 1000VA	6 min	4 hours
UPS 2000VA	6 min	4 hours
UPS 3000VA	5 min	4 hours

Additional External Battery Cabinets are available if more back-up time is needed.

3. Safety Information

Information presented here is vital to all personnel and please also read the UPS safety manual.

Storage and Transportation

Please handle with extreme caution since a high amount of energy is contained with the batteries. Always keep the unit in position as marked on the packaging and never drop the unit.

Installation

If flammable substances such as gases or fumes are present or if the room is airtight, a safety hazard situation exists, in which no electrical equipment should be operated.

The instructions in this manual explain how to install the UPS safely. Not acknowledging such electrical hazards may be fatal, so keep this manual for all future reference.



WARNING!

It is strongly advisable not to open the UPS cabinet as the components have very high voltage and touching them may be fatal. Only a technician from the manufacturer or an authorized agent may service the unit.

This UPS unit's output receptacles carry live voltage even when not connected to a power supply as it has its own energy source.

User's operations

The only operations that users are permitted to do are:

- Turning the UPS unit on and off
- Operating the users interface
- Connecting data interface cables
- Changing the batteries

All such operations are to be performed exactly as instructed in this manual. The greatest care possible must be taken for any of these operations and any change thereof may prove very hazardous to the operator.

4. Storage

Please adhere to the following instructions if the UPS is not installed immediately:

- Store the equipment as is in its original packing and shipping carton
- Do not store in temperatures outside the range of +15°C to +25°C.
- Ensure that the equipment is fully protected from wet or damp areas and from moist air.

In order to maintain the vitality of the batteries, ensure that the UPS is recharged every 6 months for at least 8 hours.

5. Installation

5.1 Environment

Ensure that all environmental concerns and requirements are met according to these technical specifications, otherwise the safety of installation personnel cannot be guaranteed and the unit may malfunction.

Ensure that you remember the following when locating the UPS system and battery options:

- Avoid extremes of temperature and humidity. Maximal battery life can be attained with a recommended temperature range of 15 °C to 25 °C.
- Provide protection for the equipment from moisture.
- Space and ventilation requirements must be met. Ensure there is 100mm behind and 50mm on the sides of the UPS for ventilation.
- Ensure that the front of the UPS remains clear for user operation.

The External Battery Cabinets has to be installed next to the UPS or under the UPS.

Installations with accessories of “Vertical” and “Wall-mounted” types:

Please install the vertical and wall-mounted types of units according to the following illustration.

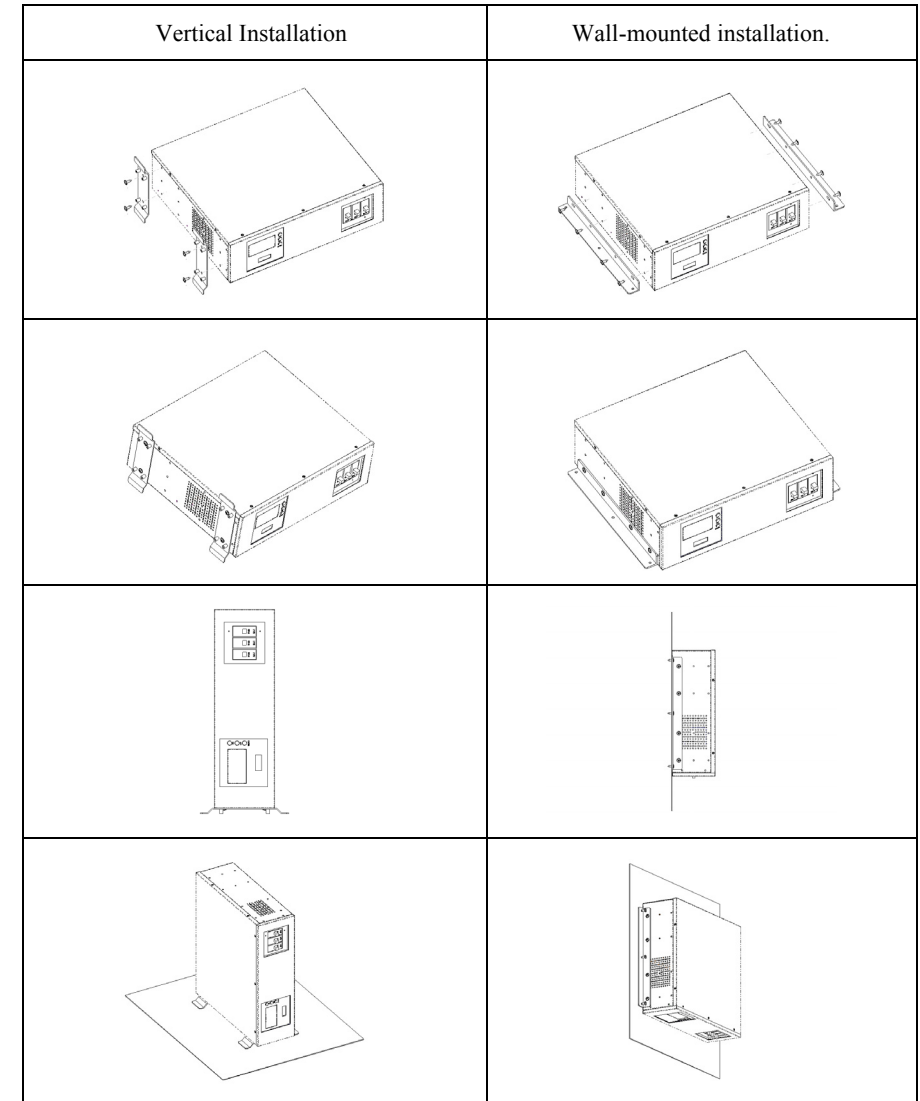

Note: The product diagrams below are used for illustrating installation procedure only. They are not exact the same with the product you purchased.



Installation with accessories of “Rack-mounted” types:

Please install the types of units according to the following illustration.

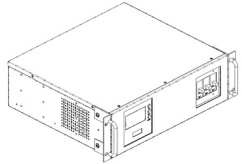
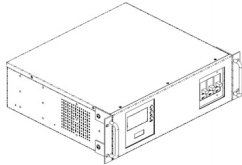
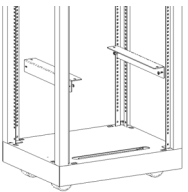
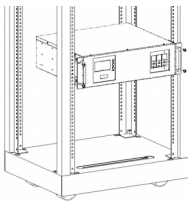
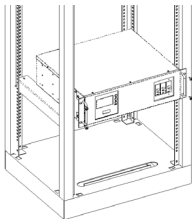
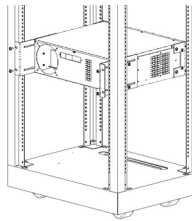
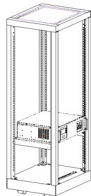
Note: The product diagrams below are used for illustrating installation procedure only. They are not exact the same with the product you purchased.

<p>Installation with bottom bracket. Part No: RMB-06, 2 PCS. Screw: M5*11, 4 PCS.</p>	<p>Installation with rear bracket Part No: RMB-01, 2PCS. Screw: M5*11, 4 PCS.</p>
	
	
	
	

5.2 Rear panel views

1KVA Rear Panel

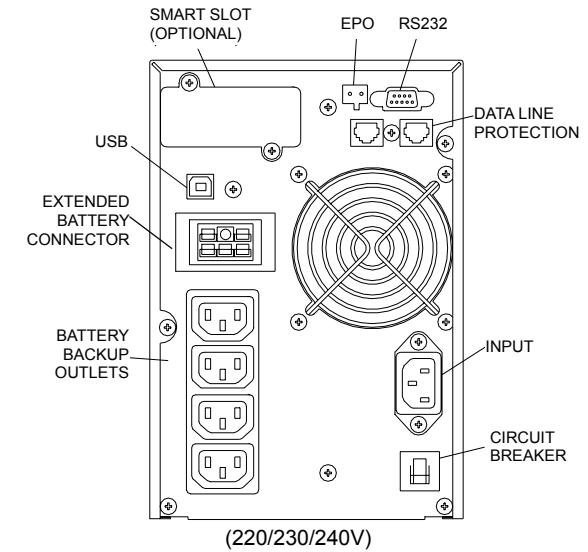
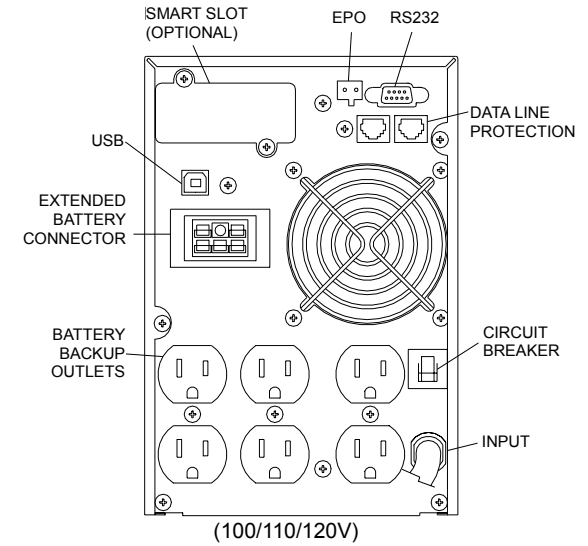

2KVA-3KVA Rear Panel

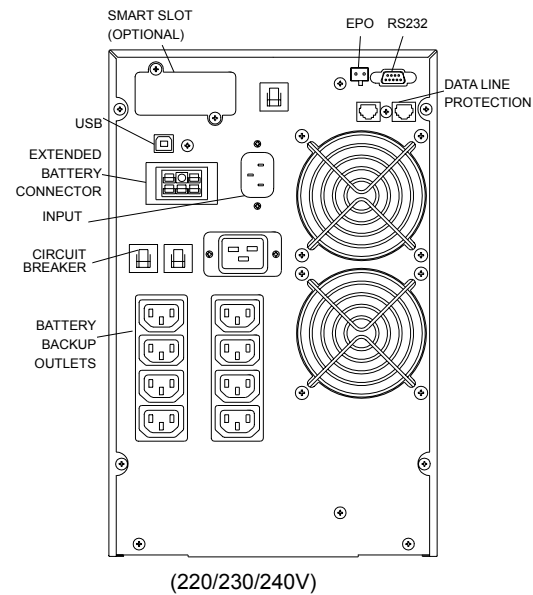
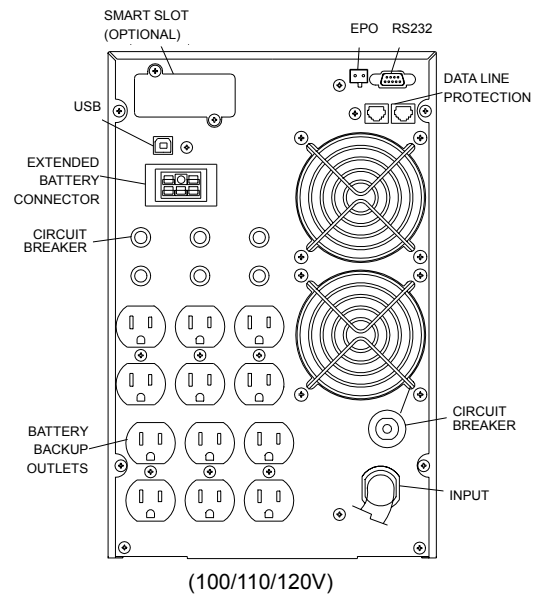

RM(1U) 1KVA Rear Panel

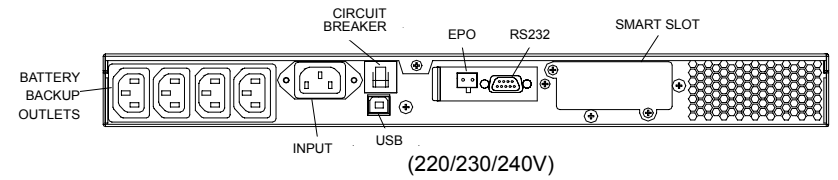
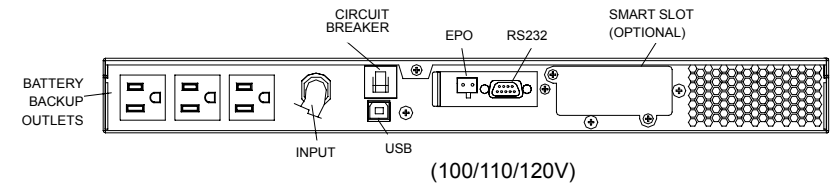

RM(2U) 1KVA Rear Panel

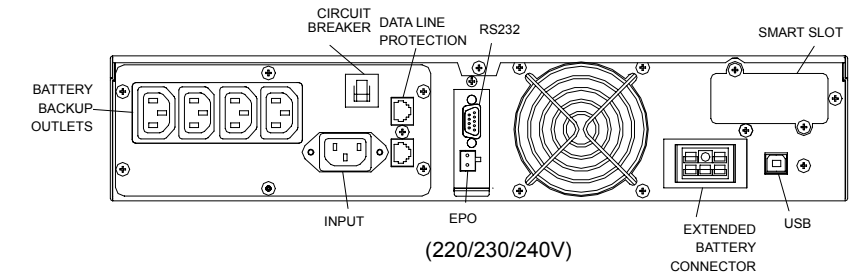
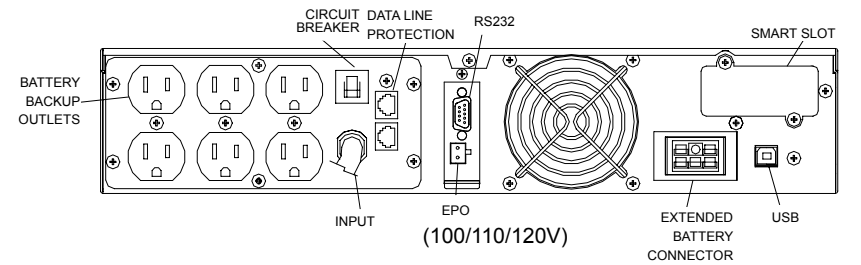

RM(2U) 2K-3KVA Rear Panel

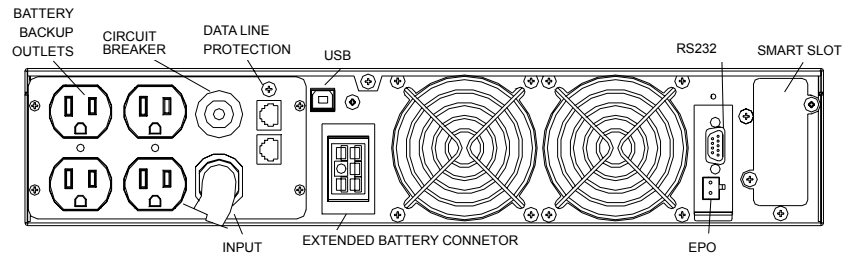

(100/110/120V)

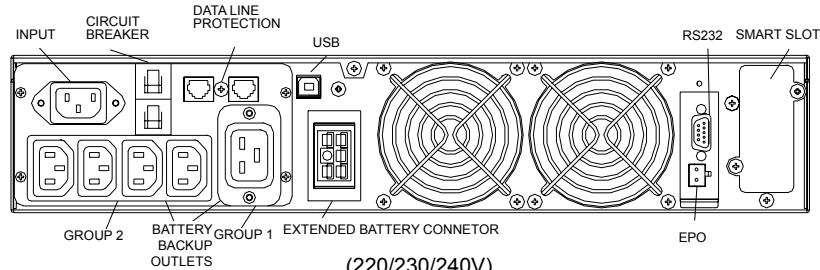

(220/230/240V)

5.3 Connection to mains and loads (1000 - 3000 VA)

The accessories with UPS

100/110/120V UPS	Accessory	
1000 VA	User's Guide x 1 Telephone Line x 1 Software x 1	Input Power Cord x 1 RS232 x 1
2000 VA	User's Guide x 1 Input Power Cord (built-in) Software x 1	Telephone Line x 1 RS232 x 1
3000 VA	User's Guide x 1 Input Power Cord (built-in) Software x 1	Telephone Line x 1 RS232 x 1

- Ensure that the UPS is disconnected from mains and loads while connecting the External Battery Cabinets, if needed.
- Use the battery cable that comes with the External Battery Cabinet to connect the External Battery Cabinet to the UPS. Connect a second battery cabinet to the first one with the cable provided if more than one is to be installed.
- Be aware of UPS parameters and changing the Battery pack quantity when using the external battery cabinets (see chapter 7.2)
- Connect the Input cable to the UPS and connect the other end to a grounded outlet. The batteries will automatically charge when connected to the mains. Please realize that although you may start using the UPS immediately, maximum back-up time will still not be available, so it is recommended to charge the batteries for a minimum of 8 hours before use.
- If unit instantly shows a "Site Wiring Fault", rotate the connector (Schuko) (see chapter 7.4).
- After charging, connect the loads to the UPS (see the example in fig 3).
- Do not connect any devices that have the possibility of overloading the UPS or drawing half-wave rectified current, such as hair dryers or vacuum cleaners.
- Should computer or alarm connections be used, use connections according to chapter 6 of the manual provided with that option. The connections can be referred to on the rear panel.
- The installation is now complete

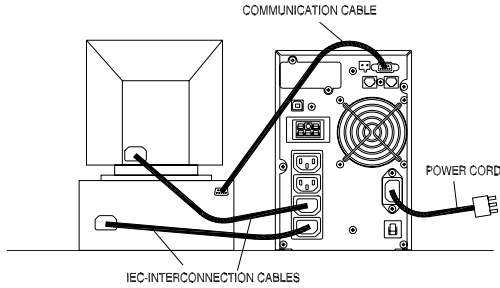

Fig. 3 Example of Installation

5.4 Default settings at the factory

On the LCD display you will find several of the UPS parameters to select. Default settings are as follows:

Settings	Selection	Factory default
Output Voltage Setting	100/110/115/120/127 Vac	120V (FOR 1x0 series)
	208/220/230/240 Vac	230V (FOR 2x0 series)
Input/Bypass Voltage	±10%	+10/-15%
	+10/-15%	
	+15/-20%	
Input/Frequency	±2%	±5%
	±5%	
	±7%	
HE Mode Setting	On/Off	Off
Free Run Mode	On/Off	On
Bypass Enable/Disable at free run mode	Disable/Enable	Disable
Alarm silence	On/Off	Off
Site wiring alarm	Enable/Disable	Disable
External Battery pack setting	0, 1, 2	0

You may change default settings, but we recommend that this is done after installation and before starting up loads. Read UPS configurations in chapter 7.2 for more information.

6. Computer and Alarm connections

At the back of the UPS is an interface allowing direct communication with your computer system, the location of which can be found in figure 2. There is a RS232 serial data interface, one USB data interface and an emergency power off switch supplied. However, the RS232 port cannot be used when the USB interface is in use.

In addition there is an optional interface slot that allows you to install different communications cards. It can be used parallel with either the RS232 or USB ports.

Currently there are two cards available for the optional interface slot. An SNMP/WEB card allows management and monitoring over a network or internet, and the AS/400 card allows voltage free relay contacts. Your local dealer will have more information about these option cards.

Connecting the UPS to a Computer

The communication device for the UPS and PC comes as a complete package with power management software. Only the communication cable provided with UPS may be used to connect to your computer, which is accomplished through the UPS RS232 port. Also ensure that the operating system on your computer is supported. Instructions provided in the power management software will help with this installation.

Other advanced power protection solutions such as SNMP are provided by your dealer.

RS-232 Standard Interface port

The RS-232 interface uses a 9-pin female D-sub connector. This information consists of data about utility, load and the UPS. The interface port pins and their functions are identified in the following table.

Pin #	Signal name	Direction (re UPS)	Functions
2	TxD	Output	TxD Output
3	RxD	Input	RxD / Inverter Off Input
5	Common		Common
6	CTS	Output	Ac Fail Output
8	DCD	Output	Low Battery Output
9	RI	Output	+8-24 VDC Power

Caution! Max rated values 24Vdc/50mA

USB port

Connecting the UPS to your computer is accomplished through the USB port on the back of your computer. USB compliant hardware and operating system will be necessary including installation of a UPS driver. The serial port cannot be used when using the USB port.

6.1 EPO port (emergency power off)

A customer-supplied switch located remotely can be used to open the EPO connection and allows UPS output receptacles to be switched off. Since the EPO shuts down the equipment immediately, orderly shutdown procedures are not followed and not by any power management software. The UPS will have to be manually restarted in order to regain power to the outlets.

6.2 Data Line protection (1000 - 3000 VA)

The network transient protector, located on the back panel, has both IN and OUT jacks, and houses a single RJ-45 (10BaseT) network connector or RJ-11 telephone line connector. Connect the input connector to the jack labeled IN, and the output connector to the jack labeled OUT.

6.2 Load segments (1000 - 3000 VA)

The power management software controls the sets of receptacles known as load segments which provides organized shutdown and startup of the equipment. Less critical equipment can be turned off during power outages saving battery power for critical loads. The power management software manual has more details regarding this. The load group status can be viewed from the LCD display and can be changed if necessary. These load segments are usually handled with the UPS management software. Refer to chapter 5.2 regarding the two load segments that come with each model.

7. User's guide to operations

Necessary information for operation of the unit is covered in this chapter. Normally the UPS runs automatically, but on those few occasions such as just after installation, all the starting and shutting down procedures are described herein.

7.1 Starting and shutting down the UPS

Starting the UPS

- Ensure that installation was correct and successful and that the input power cable is connected to a well-grounded outlet.
- The UPS can be started by pushing the "ON/OFF" button on the front panel.
- The UPS should now start its inspection of: internal functions, main synchronization and inverter startup. Then power should start to be supplied via the outlets.
- During this inspection, the LCD will display "Ready on". The LED shall light up when output power has commenced and the LCD will display "Line mode".
- Switch on the loads.

Shutting down the UPS

- Shut down and turn off the loads.
- Push the "ON/OFF" button on the front panel for five seconds. The alarm will sound and the UPS will shut down.
- The LCD will display UPS OFF for a few seconds.
- In emergency situations, the EPO located on the back of the unit should be used.

7.2 Button Operation

Please note the three operating buttons on the front panel:

1. (a). Push the "ON/OFF" button (at least 3 seconds) to turn on the UPS.
(b). When UPS is working, push the "ON/OFF" button (at least 3 seconds) to turn off the UPS.
2. Use "Enter" button to check content of UPS and the method is listed below:
(a). Push the "ENTER" button (at least 2 seconds) to check content of UPS. Each content can be displayed by pressing at once, and it has fifteen kinds of function to be checked.

(b) If no pressing within 10 seconds, it will return to original status.

3. “FUNC” is a Function button. Each function can be enabled by pressing this button.

(a). Push the “FUNC” button (at least 2 seconds) to choose which function that you want.

Each content can be displayed by pressing at once, and it has fourteen kinds of function to be checked.

(b). After choosing the function, push the “ENTER” button to enter the function that you want.

(c). Push the “FUNC” button to choose other function again.

(d). Push the “ENTER” button to enable your function.

(e). Push the “ENTER” button to confirm and enable your function.

(f). If no pressing within 10 seconds, it will return to original status.

7.3 Control Panel functions

Operation of the UPS is indicated on the monitor panel with five LED indicators and an LCD screen. This display is also capable of alerting the user with audible alarms.

ON	This green LED is lit when UPS has been turned on.
ON-LINE	When the UPS is in normal or static bypass modes, there is voltage at the output terminals and this LED will light up in green.
ON-BAT	While operating in battery mode.
BYPASS	While operating in bypass mode, this LED will light up in yellow.
FAULT	If any internal error occurs in the UPS, this LED will light up in red and give off an audible alarm. Press any of the buttons on the front panel to turn off the alarm.

Status of the UPS, measurements and alarms are all indicated on the LCD screen.

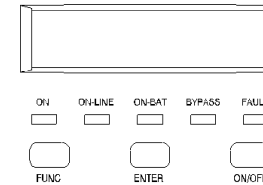

Figure 6. Control panel

Normal display

The UPS status is shown in normal display mode. From here you have a choice to go to UPS meters display and the Setting display by pushing the button.

UPS meters display

Various measurements are available through the UPS meters display; pressing the button will scroll through the following meters:

LCD message	Description
O/P VOLT= xxx, xV	Shows Output AC voltage
O/P FREQ= xx, x Hz	Shows Output Frequency
I/P VOL T= xxx, xV	Shows Input AC voltage
I/P FREQ= xx, x Hz	Shows Input Frequency
BAT VOLT= xx,xV	Shows Battery Voltage
O/P LOAD%= xx%	Shows Load % of max load
O/P W= xW	Shows Output Watts
O/P VA= xVA	Shows Output VA
O/P CURR= xA	Shows Output Current
BACKUP TIME= xx min	Shows Estimated Backup time in minutes
BAT CHARG= xx%	Shows approximate percentage of Battery capacity
TEMPERATURE= xxC	Shows approximate ambient temperature
BAT PACK NUM= x	Shows External Battery Pack Number
RATING = xxxxVA	Shows UPS Rating
CPU VERSION xx.x	Shows CPU Version

UPS configurations

1. Various settings that have been chosen are shown in the UPS setting display.
2. To enter configuration mode, press the “FUNC” button for one second. The first configuration parameter will be shown on the LCD display.
3. Press the “FUNC” button to scroll through the parameters.
4. Press the “ENTER” button to select the parameter.
5. Press the “FUNC” button to scroll through the options for the selected parameter; Press the “ENTER” button to select the option.

You may be prompted to save the selection, if so press the “ENTER” button to either confirm or save your selection. Other options are saved and started automatically. See the table below for further details.

6. If no buttons are pressed (or user inactivity) for ten seconds, the UPS shall exit the configuration mode and return to normal mode displaying Line mode.

Caution!

The factory default settings do not necessarily have to be changed, although you are free to tailor the UPS to your specific needs.

Settings	LCD display	Explanation	Selection	Factory default
Output Volt. Setting	O/P V Setting	Select Nominal Voltage	208/220/230/240 V	230V
			100/110/115/120/127 V	120V
Input/Frequency	I/P F Setting	Select input frequency range when UPS goes into free run mode	±2% ±5% ±7%	±5%
Input/Bypass Voltage	I/P Bypass Set	Select Input Voltage range when bypass is available	±10% +10/-15% +15/-20%	+10/-15%
Free Run Mode	Free Run Set	Select if UPS can run in Free run mode (unsynchronized)	ON/OFF	ON
Bypass Enable/Disable at Free run mode	Bypass disable	If Enable is chosen, the UPS can go to bypass when unsynchronized.	Disable/Enable	Disable
He mode Setting	HE Mode Set	Select if UPS runs in high efficiency mode	ON/OFF	OFF
Force Manual Bypass	Manual bypass	Permanently force UPS to bypass. For service only.**	ON/OFF	OFF
Management of Load groups	Outlet Setting	You can put the two load groups on and off from front panel	1 ON & 2 ON 1 OFF & 2 ON 1OFF & 2 OFF 1 ON & 2 OFF	Both load segments ON
Do Battery Test	Battery Test	Detect battery is normal or not.		
Silence Function	Silence Set	Enable or disable silence function	ON/OFF	OFF
Number of External battery Packs	Bat Cabinet Set	This setting is needed For UPS to predict Backup time	0 (only internal batteries) 1(one external cabinet) 2 (two external cabinets)	0
Site wiring alarm	Sit Fault Set	You can enable or disable the site wiring alarm	Enable /Disable	Disable
Select Language	Language	Select load language	English, German, French, Spanish, Italian.	English
Set Generator Mode	Generator	Set unit in generator mode.***	ON/OFF	OFF
Set RS232 communication	RS232 Control	Set RS232 communication enable or disable	Enable/Disable	Enable

Manual test of the UPS

Manual UPS or Manual Battery tests can be conducted from the UPS configuration as well and are functional even when the UPS is not charging the battery.

Manual Battery test: Scroll the parameters until Manual Bat test displays on the LCD.

Press the “Enter” button twice.

***) Note: In order for the UPS and power management software to operate normally, Manual Bypass should always be set to OFF as the load will not be protected by the unit when Manual Bypass is ON. This is aimed for operating an external maintenance bypass switch.

***) Note: You should turn UPS off and keep the AC power before you use “Generator” function. (even you want to select “\Generator\OFF” to back to normal mode).

7.4 Interpreting UPS messages

Troubleshooting procedures described here give simple instructions in determining UPS malfunctions.

Start the troubleshooting procedure if you witness any alarm indication on the control panel.

Alarm indicators

The UPS gives the following audible alarms:

- If UPS is on battery and the ON BATTERY LED is on, UPS will beep every 5 seconds.
- If the battery capacity is low and the ON BATTERY LED is flashing, the UPS will beep twice every 5 seconds.
- If UPS is on bypass and the BYPASSED LED is on, UPS will no beep.
- If UPS has an internal fault and the FAULT LED is on, the UPS will give a constant audible alarm displaying the cause on the LCD display.

Silencing an alarm

By pressing any of the three buttons on the front panel, the alarm can be turned off, except when the battery is low, which will cause the alarm to resound.

On the LCD display, you can also choose silent alarm mode which will not warn you of any malfunction audibly.

7.5 Trouble shooting

Displayed on LCD	Audible Alarm	Alarm Description	What You Should Do
Output Overload	Two Beeps per second	The UPS is overloaded (in Line Mode). Your equipment needs more power than the UPS can provide. The UPS operates in bypass.	Shut off the least important equipment connected to the UPS. If this solves the overload problem, the UPS will switch from bypass back to normal operation.
Battery Test	No Beeps	The UPS is doing a battery test.	No action needed. The UPS will return to normal operation when it successfully completes the battery test.
Over-Charge	Constant beep	Batteries are overcharged.	Turn off protected loads. Turn off UPS and call your local dealer
Low Battery	2 beeps every 5seconds	The unit is operating on Battery Power and will shut down soon due to very low battery voltage	The unit will restart Automatically when acceptable power returns.
On-Battery	Once every 5 seconds	The unit is operating on Battery Power.	Save your data and perform a controlled shutdown.
Charger Failure	Constant beep	Charger has failed.	Phone the local dealer
Over-Temperature	Constant beep	High ambient Temperature.	Make sure the unit’s fans and vent holes are not blocked, and make sure the ambient surrounding temperature is not above 40 degree C. If these conditions did not solve the problem, call your service representative.
Output Short	Constant beep	Output short circuit	Call the Local dealer
High output Voltage	Constant beep	High output voltage	Call the Local dealer
Low Output Voltage	Constant beep	Low output voltage	Call the Local dealer
Bus Fault	2 Beeps per second	High internal DC bus Voltage.	Turn off protected loads. Turn off UPS and call your local dealer
Site wiring Fault	1 Beep per second	Voltage detected Between Neutral and Ground	UPS mains connector polarity Wrong. Rotate the connector (Schuko). UPS installed to mains supply without ground. See page 15 on how to disable the Site wiring alarm
Line abnormal	1 Beep per second	Wrong AC Line backed up during auto restart	

8. Maintenance

With a minimal amount of maintenance, you can expect the UPS to application, otherwise consider changing the batteries. have a long life free of trouble. The most critical issues for the reliability of the UPS are environmental issues. Ensure that the temperature and humidity are always according to specifications and keep the area around the unit clean and dust free.

At a temperature of 25°C, the typical battery lifetime is 4 years.

Also check at regular intervals of 6 to 12 months whether the back-up time of the battery is adequate for its

8.1 Replacing batteries

The batteries may be replaced without having to turn the UPS off or disconnecting the load due to the hot-swappable battery feature.

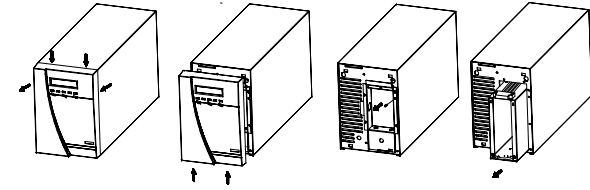

The following is a step-by-step tutorial for replacing the batteries:

1. The front panel of the UPS can be removed by pushing where the arrows indicate in the pictures above. Next, unscrew the screws and remove the metal battery cover.
2. Remove the battery cartridge from the UPS.
3. Replace the batteries.
4. Push the cartridge with the new batteries back into the UPS.
5. Reinstall the metal plate and the front panel.



WARNING!

Batteries may cause electrical shock or burn from high short circuit currents. Please observe the following precautions: 1. Remove jewelry and metal objects such as watches and rings. 2. Use tools that have insulated handles. 3. Keep tools and other metal objects from contacting and away from the batteries.

ELECTRIC ENERGY HAZARD. Do not attempt to rewire, alter, or change any battery wiring or connectors. Attempting to make such alterations can cause injury.

Replace the batteries with the same number and type as originally installed batteries.

DO NOT DISCONNECT the batteries while UPS is in Battery mode.

Replacing batteries (1000 - 3000 VA)

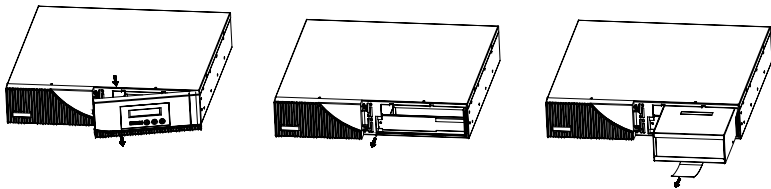

9. Warranty

Warranty on this product is valid against defects in material and workmanship for a period of 24 months from its original date of purchase.

10. Technical Specifications

10.1 Power Range 1000-3000 VA (100/110/120V)

GENERAL

Rated power 1000 VA, 2000 VA, 3000 VA at p.f 0.7
Technology On-line, double conversion topology with automatic bypass

INPUT

Phase: Single phase with ground
Bypass Voltage 96--138 VAC (user selectable)
Input Voltage range: 60/70/80VAC-144 VAC
Frequency: 50/60 Hz. Auto selection
Frequency window from mains 45-65 Hz
Synchronization window ± 3 Hz.
Input current 1000 VA 8.2A, 2000 VA 16.5A, 3000 VA 24.7A
Input Power factor: 0.97

OUTPUT

Output Voltage: 100/110/115/120/127 VAC, selectable from LCD panel
Voltage regulation: $\pm 2\%$
Voltage distortion: $< 5\%$ THD at full non-linear load, $< 3\%$ THD at full linear load
Frequency regulation ± 0.25 Hz (battery or free running mode)
* 60V at 40% load, 70V at 70%, 80V at 100%.

ENVIRONMENTAL

Ambient temperature: $+0\text{ }^{\circ}\text{C}$ to $+40\text{ }^{\circ}\text{C}$
Recommended temperature: $+15\text{ }^{\circ}\text{C}$ to $+25\text{ }^{\circ}\text{C}$
Storage temperature: $-15\text{ }^{\circ}\text{C}$ to $+50\text{ }^{\circ}\text{C}$
Cooling: Forced air-cooling
Humidity: 0-95%, non-condensing
Audible noise: < 40 db normal and battery mode

10.2 Power Range 1000-3000 VA (220/230/240V)

GENERAL

Rated power 1000 VA, 2000 VA, 3000 VA at p.f 0.7
Technology On-line, double conversion topology with automatic bypass

INPUT

Phase: Single phase with ground
Bypass Voltage: 184-265 VAC (user selectable)

Input Voltage range: 120/140/160 VAC-276 VAC
Frequency: 50/60 Hz. Auto selection
Frequency window from mains 45-65 Hz
Synchronization window ± 3 Hz.
Input current 1000 VA 4A, 2000 VA 7.7A, 3000 VA 12A
Input Power factor: 0.97

OUTPUT

Output Voltage: 208/220/230/240 VAC, selectable from LCD panel
Voltage regulation: $\pm 2\%$
Voltage distortion: $< 5\%$ THD at full non-linear load, $< 3\%$ THD at full linear load
Frequency regulation ± 0.25 Hz (battery or free running mode)
* 120V at 40% load, 140V at 70%, 160V at 100%.
Dynamic response: $\pm 9\%$ max from 100% to 20% or from 20% to 100% linear load
Overload capacity: 100-125% 1 min, 125-150% 10 sec
Efficiency: greater than 86%

ENVIRONMENTAL

Ambient temperature: $+0\text{ }^{\circ}\text{C}$ to $+40\text{ }^{\circ}\text{C}$
Recommended temperature: $+15\text{ }^{\circ}\text{C}$ to $+25\text{ }^{\circ}\text{C}$
Storage temperature: $-15\text{ }^{\circ}\text{C}$ to $+50\text{ }^{\circ}\text{C}$
Cooling: Forced air-cooling
Humidity: 0-95%, non-condensing
Audible noise: < 40 db normal and battery mode

10.3 Power Range 1000-3000 VA (100/110/120V 19" Rack-mount model)

GENERAL

Rated power 1000 VA, 2000 VA, 3000 VA at p.f 0.7
Technology On-line, double conversion topology with automatic bypass

INPUT

Phase: Single phase with ground
Bypass Voltage 96--138 VAC (user selectable)
Input Voltage range: 60/70/80VAC-144 VAC
Frequency: 50/60 Hz. Auto selection
Frequency window from mains 45-65 Hz
Synchronization window ± 3 Hz.
Input current 1000 VA 8.2A, 2000 VA 16.5A, 3000 VA 24.7A
Input Power factor: 0.97

OUTPUT

Output Voltage: 100/110/115/120/127 VAC, selectable from LCD panel
Voltage regulation: $\pm 2\%$
Voltage distortion: $< 5\%$ THD at full non-linear load, $< 3\%$ THD at full linear load

Frequency regulation ± 0.25 Hz (battery or free running mode)
 * 60V at 40% load, 70V at 70%, 80V at 100%.

ENVIRONMENTAL

Ambient temperature: +0 °C to +40 °C
 Recommended temperature: +15 °C to +25 °C
 Storage temperature: -15 °C to +50 °C
 Cooling: Forced air-cooling
 Humidity: 0-95%, non-condensing
 Audible noise: < 40 db normal and battery mode

10.4 Power Range 1000-3000 VA (220/230/240V 19” Rack-mount model)

GENERAL

Rated power 1000 VA, 2000 VA, 3000 VA at p.f 0.7
 Technology On-line, double conversion topology with automatic bypass

INPUT

Phase Single phase with ground
 Bypass Voltage: 184-265 VAC (user selectable)
 Input Voltage range: 120/140/160 VAC-276 VAC
 Frequency: 50/60 Hz. Auto selection
 Frequency window from mains 45-65 Hz
 Synchronization window ± 3Hz.
 Input current 1000 VA 4A, 2000 VA 7.7A, 3000 VA 12A
 Input Power factor: 0.97

OUTPUT

Output Voltage: 208/220/230/240 VAC, selectable from LCD panel
 Voltage regulation: ± 2%
 Voltage distortion: < 5% THD at full non-linear load, < 3% THD at full linear load
 Frequency regulation ± 0.25 Hz (battery or free running mode)
 * 120V at 40% load, 140V at 70%, 160V at 100%.
 Dynamic response: ± 9 % max from 100% to 20 % or from 20% to 100 % linear load
 Overload capacity: 100-125% 1 min, 125-150% 10 sec
 Efficiency: greater than 86%

ENVIRONMENTAL

Ambient temperature: +0 °C to +40 °C
 Recommended temperature: +15 °C to +25 °C
 Storage temperature: -15 °C to +50 °C
 Cooling: Forced air-cooling
 Humidity: 0-95%, non-condensing
 Audible noise: < 40 db normal and battery mode

STANDARDS

Safety: EN50091-1-1
 Emissions: EN50091-2 class B
 Immunity: EN50091-2

100/110/120V Model

OUTPUT POWER	1000VA/700W	2000VA/1400W	3000VA/2100W
Connection Input	Attached power cord		
Connection Output	6 x 5-15R (US)	12 x 5-15R (US)	12 x 5-15R (US)
Battery type	Lead-acid 7.2Ah/12V	Lead-acid 7.2Ah/12V	Lead-acid 34W/12V
Number of batteries	3	6	6
Backup time/full load	6 min	6 min	5 min
Recharge time	<4 hours to 90%	<4 hours to 90%	<4 hours to 90%
Dimensions W x L x H mm	152 x 420 x 238	225 x 425 x 360	225 x 425 x 360
Weight kg	16.2	31.1	33

19” Rack-mount Model (2U)

OUTPUT POWER	1000VA/700W	2000VA/1400W	3000VA/2100W
Connection Input	Attached power cord		
Connection Output	6 x 5-15R (US)	4 x 5-15R (US)	4 x 5-15R (US)
Battery type	Lead-acid 7.2Ah/12V	Lead-acid 7.2Ah/12V	Lead-acid 34W/12V
Number of batteries	3	6	6
Backup time/full load	6 min	6 min	5 min
Recharge time	<4 hours to 90%	<4 hours to 90%	<4 hours to 90%
Dimensions W x L x H mm	428 x 425 x 84	428 x 635 x 84	428 x 635 x 84
Weight kg	17.1	31.6	32.5

19” Rack-mount Model (1U)

OUTPUT POWER	1000VA/ 700W
Connection Input	Attached power cord
Connection Output	3 x 5-15R (US)
Battery type	Lead-acid 7 Ah/ 6V
Number of batteries	4
Backup time/ full load	4 min
Recharge time	<4 hours to 90%
Dimensions W x L x H mm	428 x 525 x 44
Weight kg	15.5

220/230/240V Model

OUTPUT POWER	1000VA/700W	2000VA/1400W	3000VA/2100W
Connection Input	IEC 320 (10A)	IEC 320 (10A)	IEC 320 (16A)
Connection Output	4 x IEC 320 (10A)	8 x IEC 320 (10A) 1 x IEC 320 (16A)	8 x IEC 320 (10A) 1 x IEC 320 (16A)
Battery type	Lead-acid 7.2Ah/12V	Lead-acid 7.2Ah/12V	Lead-acid 34W/12V
Number of batteries	3	6	6
Backup time/full load	6 min	6 min	5 min
Recharge time	<4 hours to 90%	<4 hours to 90%	<4 hours to 90%
Dimensions W x L x H mm	152 x 420 x 238	225 x 425 x 360	225 x 425 x 360
Weight kg	16.2	31.1	33

19" Rack-mount Model (2U)

OUTPUT POWER	1000VA/700W	2000VA/1400W	3000VA/2100W
Connection Input	IEC 320 (10A)	IEC 320 (10A)	IEC 320 (16A)
Connection Output	4 x IEC 320 (10A)	4 x IEC 320 (10A) 1 x IEC 320 (16A)	4 x IEC 320 (10A) 1 x IEC 320 (16A)
Battery type	Lead-acid 7.2Ah/12V	Lead-acid 7.2Ah/12V	Lead-acid 34W/12V
Number of batteries	3	6	6
Backup time/ full load	6 min	6 min	5 min
Recharge time	<4 hours to 90%	<4 hours to 90%	<4 hours to 90%
Dimensions W x L x H mm	428 x 425 x 84	428 x 635 x 84	428 x 635 x 84
Weight kg	17.1	31.6	32.5

19" Rack-mount Model (1U)

OUTPUT POWER	1000VA/ 700W
Connection Input	IEC 320 (10A)
Connection Output	4 x IEC 320 (10A)
Battery type	Lead-acid 7 Ah/ 6V
Number of batteries	4
Backup time/ full load	6 min
Recharge time	<4 hours to 90%
Dimensions W x L x H mm	428 x 525 x 44
Weight kg	15.5

10.5 Battery Packs

Tower Battery Packs

	1000 VA	2000 VA	3000 VA
Battery type	Lead-acid 7.2 Ah/12 V	Lead-acid 7.2 Ah/12 V	Lead-acid 34 W/12 V
Number of batteries	6	12	12
Backup time/ full load	20 min	20 min	11 min
Recharge time	<8 hours to 90%	<8 hours to 90%	<8 hours to 90%
Dimensions W x L x H mm	152 x 420 x 238	225 x 425 x 360	225 x 425 x 360
Weight kg	16.2	40	40

19" Rack-mount (2U) Battery Packs

	1000 VA	2000 VA	3000 VA
Battery type	Lead-acid 7.2 Ah/12 V	Lead-acid 7.2 Ah/12 V	Lead-acid 34 W/12 V
Number of batteries	6	12	12
Backup time/ full load	20 min	20 min	11 min
Recharge time	<8 hours to 90%	<8 hours to 90%	<8 hours to 90%
Dimensions W x L x H mm	428 x 425 x 84	428 x 635 x 84	428 x 635 x 84
Weight kg	22	42.5	42.5