

VPC1500ACD-Panel Kit For Panel Mounting

1. Unfasten 6 screws of back aluminum cover.

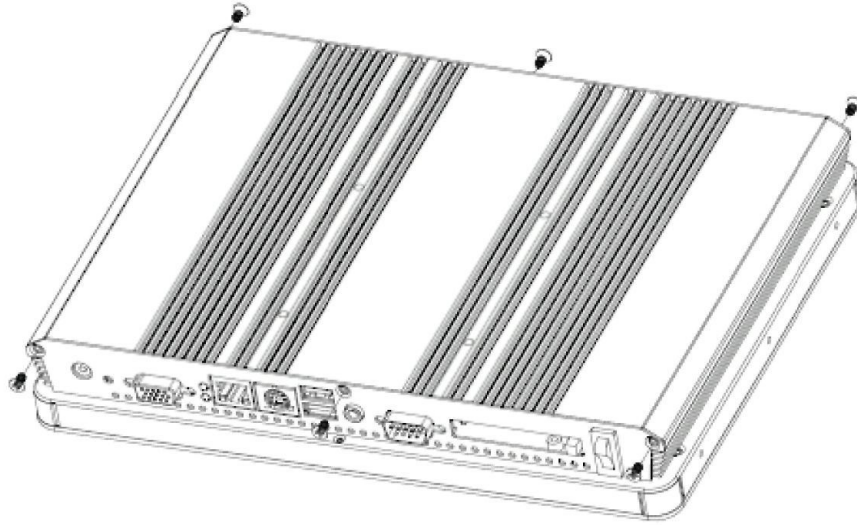

2. Unfasten screws to take off front bezel.

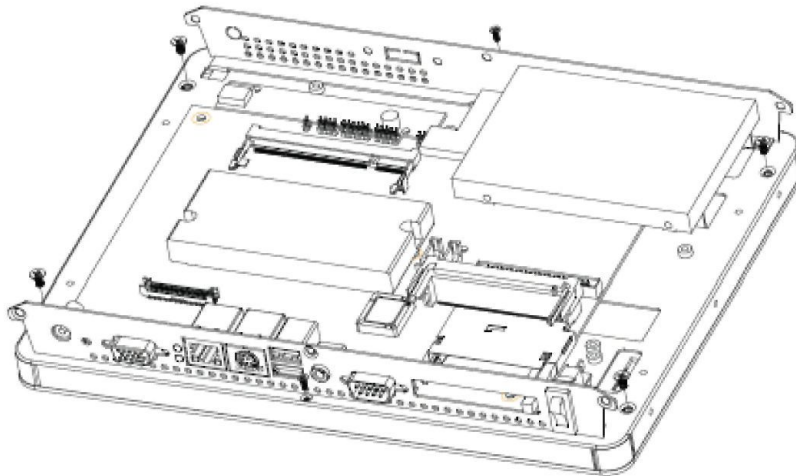

3. Change to larger front bezel and fasten screws.

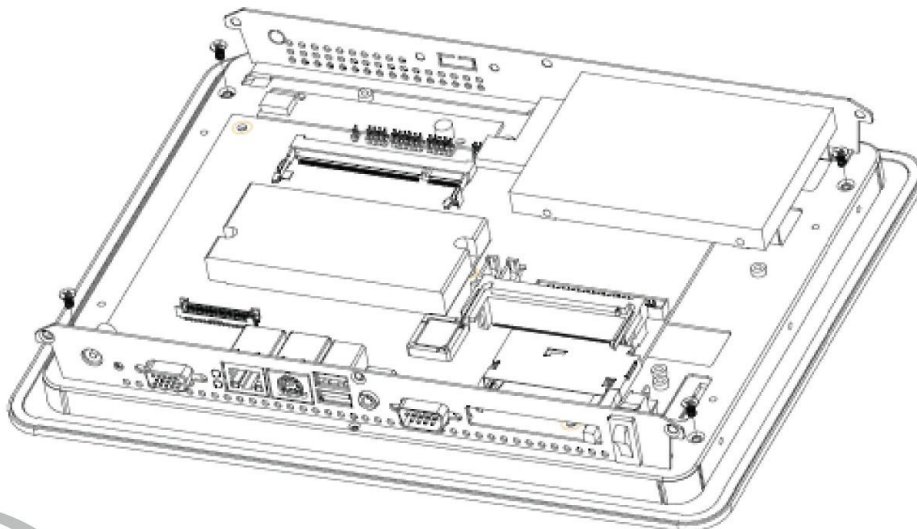

VPC1500ACD-Panel Kit For Panel Mounting

4. Fasten 6 screws of back aluminum cover.

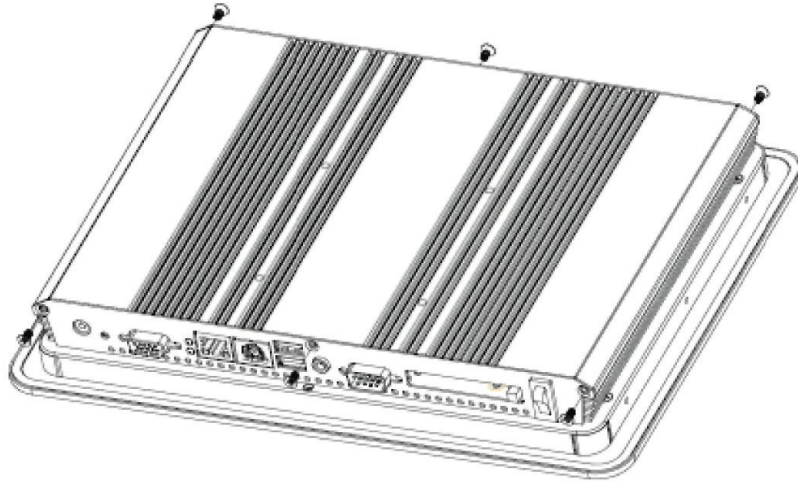

5. Add 4 side brackets and fasten screws

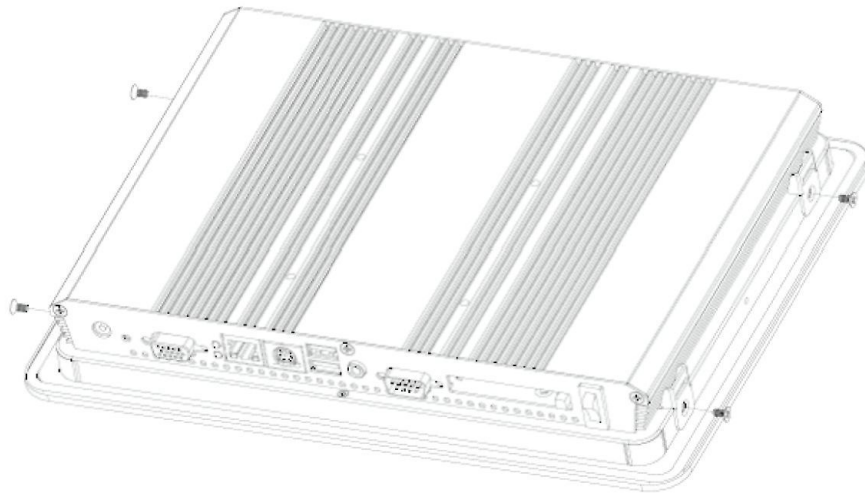

6. Put the system into the cut-out.



VPC1500ACD-Panel Kit For Panel Mounting

7. Fasten screws to fix the system.

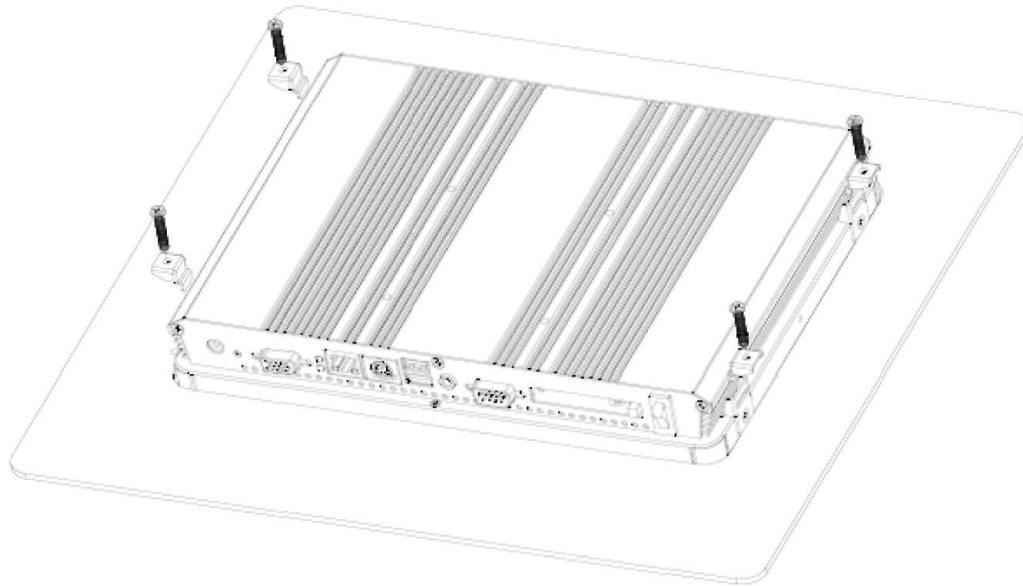

8. Complete.

